

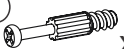















- B1**  ϕ 8x28 x16
- T1**  x10
- M1**  x10
- C2**  ϕ 20 x10
- W1**  x24
- J23**  x7
- F1**  x10
- P2**  3x16 x17

- Z2c**  x4
- Z3c**  x2
- S9**  4x16 x12

- T30**  x1
- T31**  x1
- S12**  4x30 x4
- F33**  x2
- T17**  ϕ 8x50 5x60 x4

Nr	Ausmaß			St
2	1000	200	22	1
3	672	180	16	1
4	672	180	16	1
5	330	669	20	3
6	647	158	16	1
7	647	158	16	1
8	309	155	16	4
9	316	155	16	2
10	966	159	16	1
11	669	330	2	1
12	669	324	2	1
13	669	324	2	1

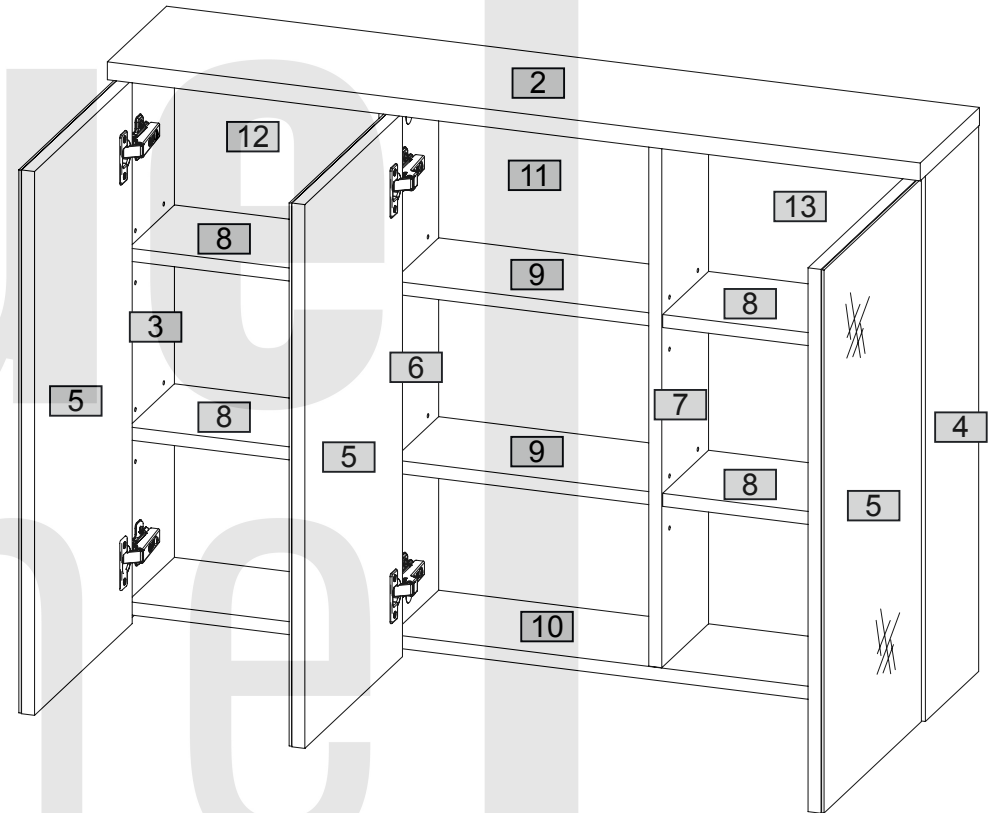

1

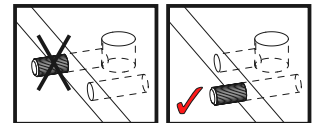
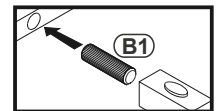
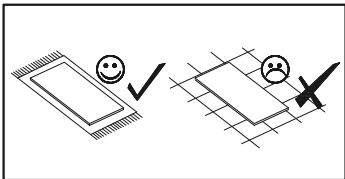
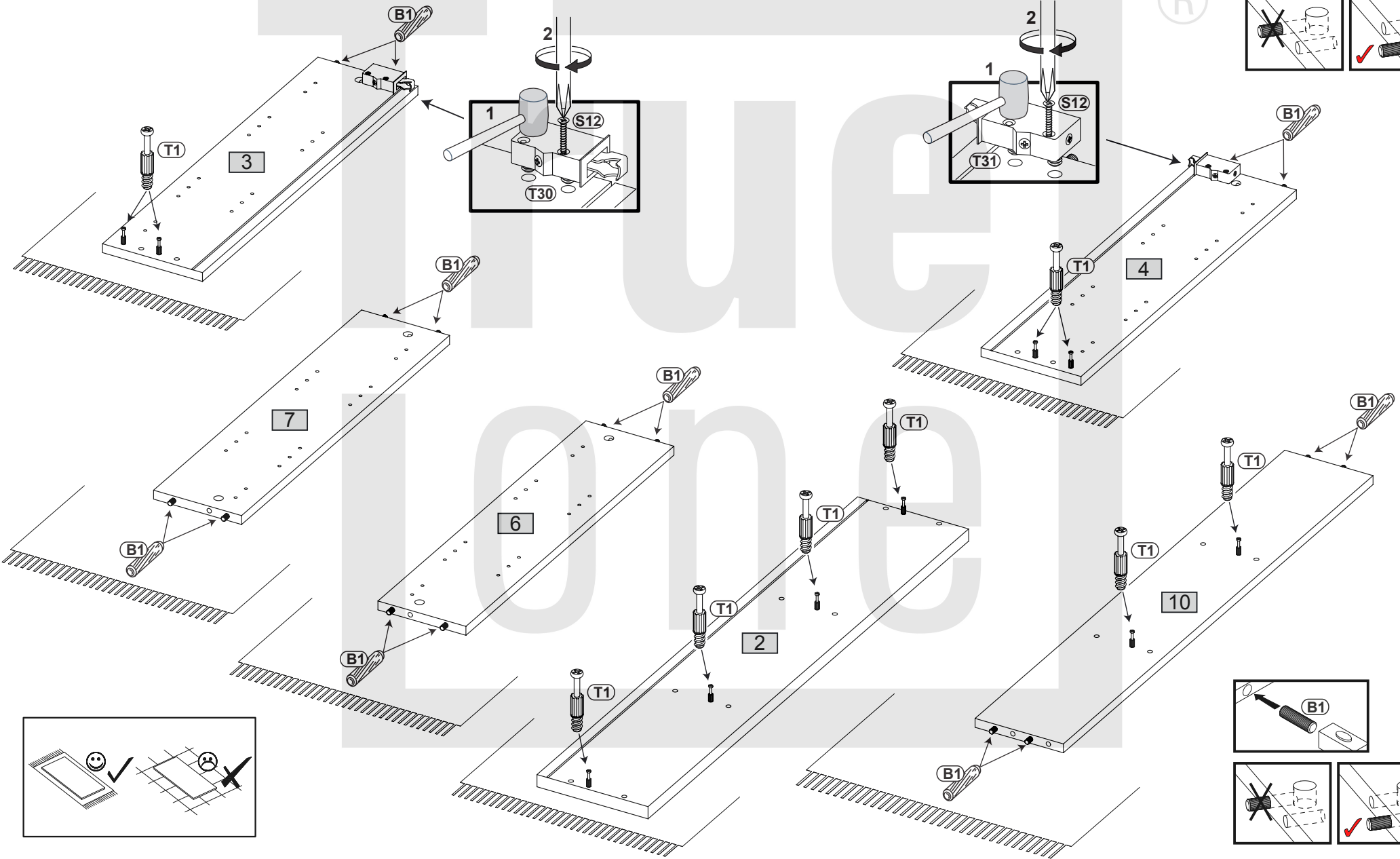
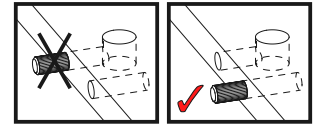
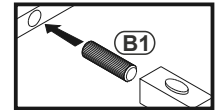
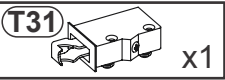
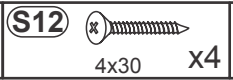
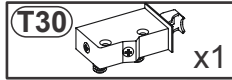
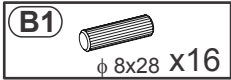
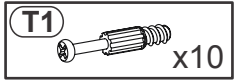

2

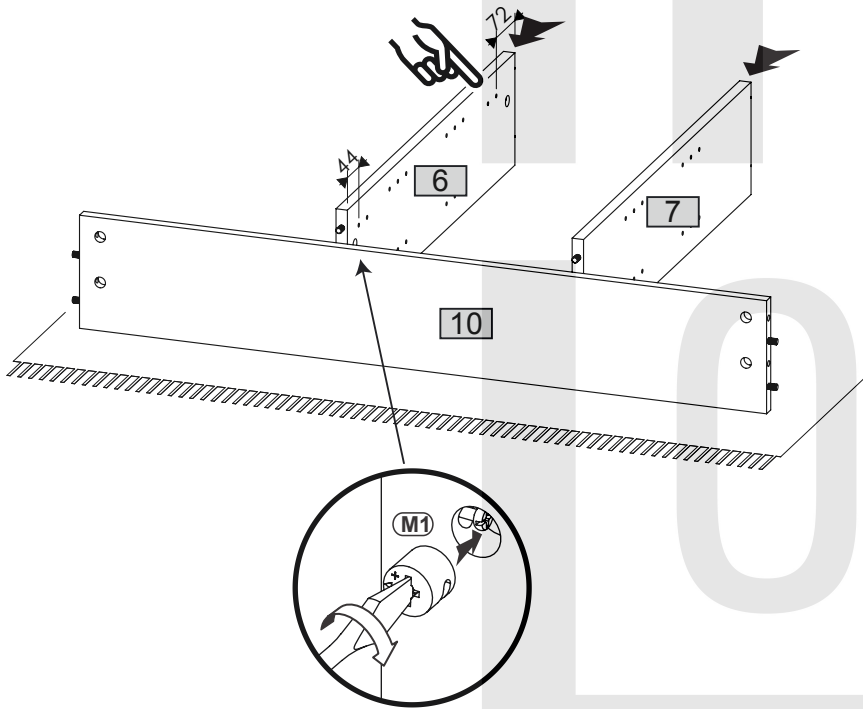

3

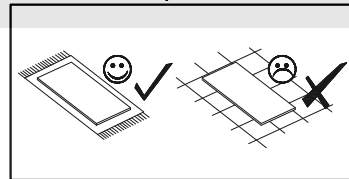
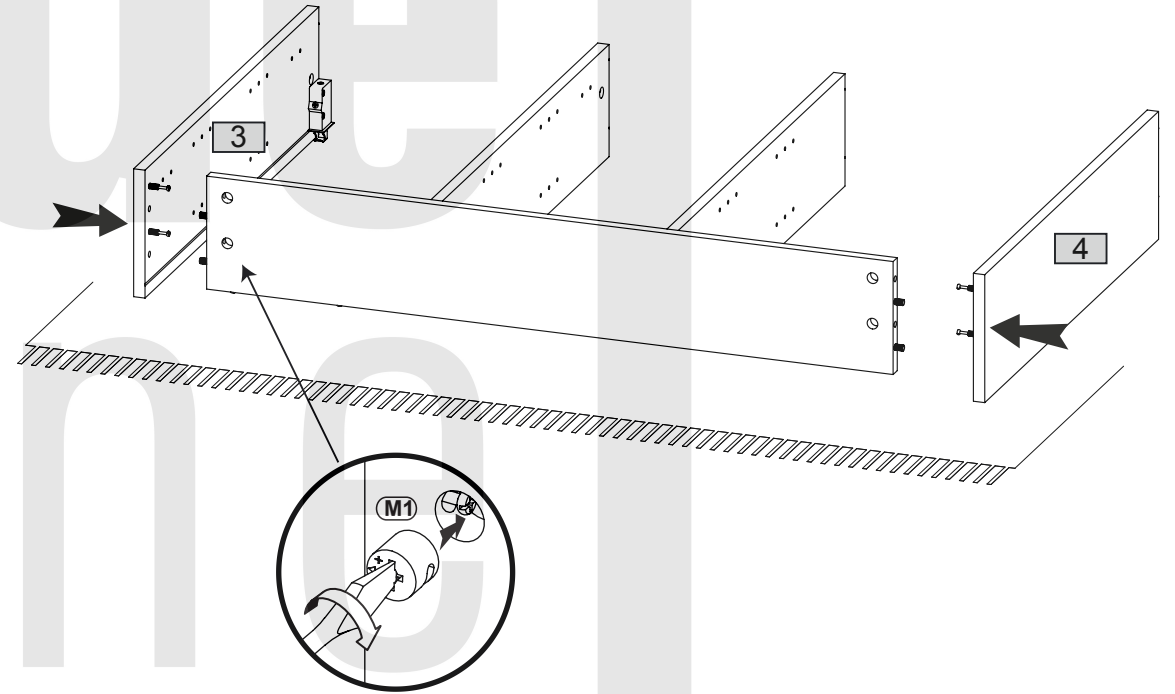

4

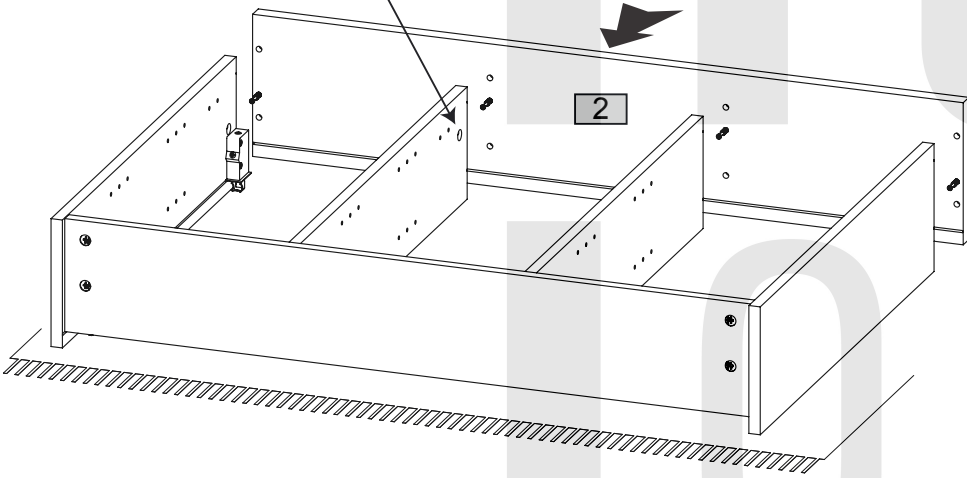
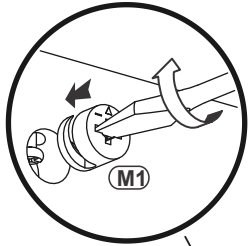

5

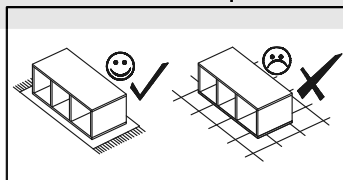
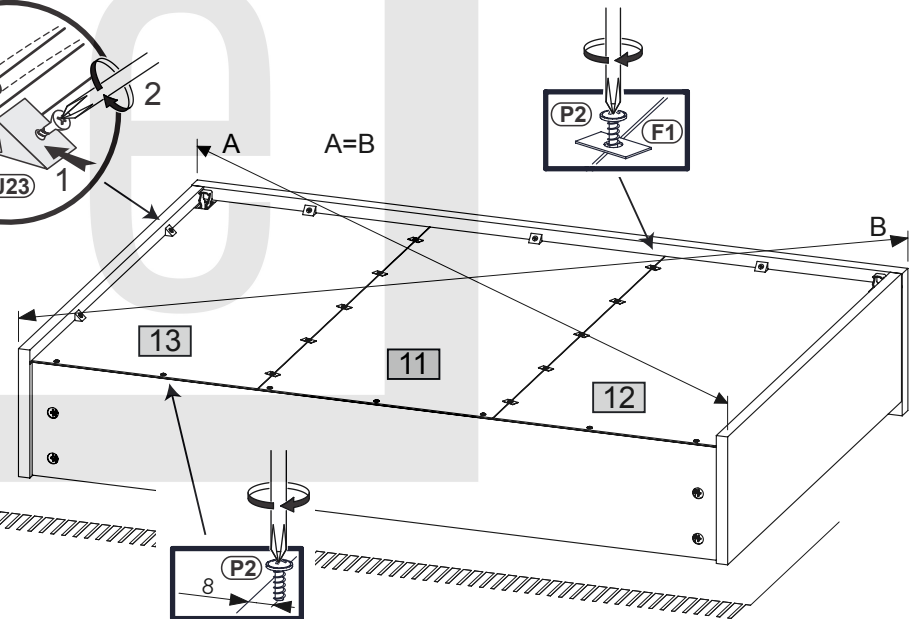
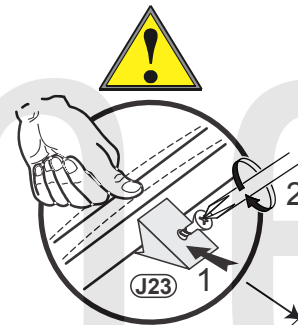
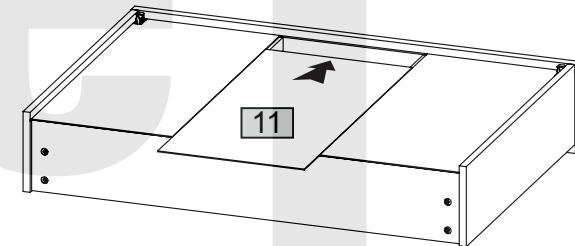
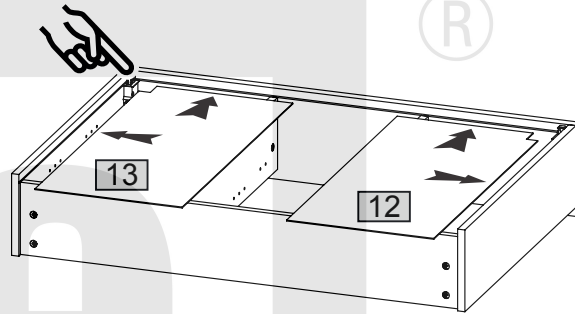
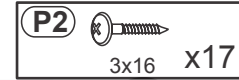
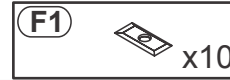
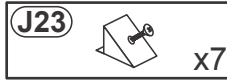

6

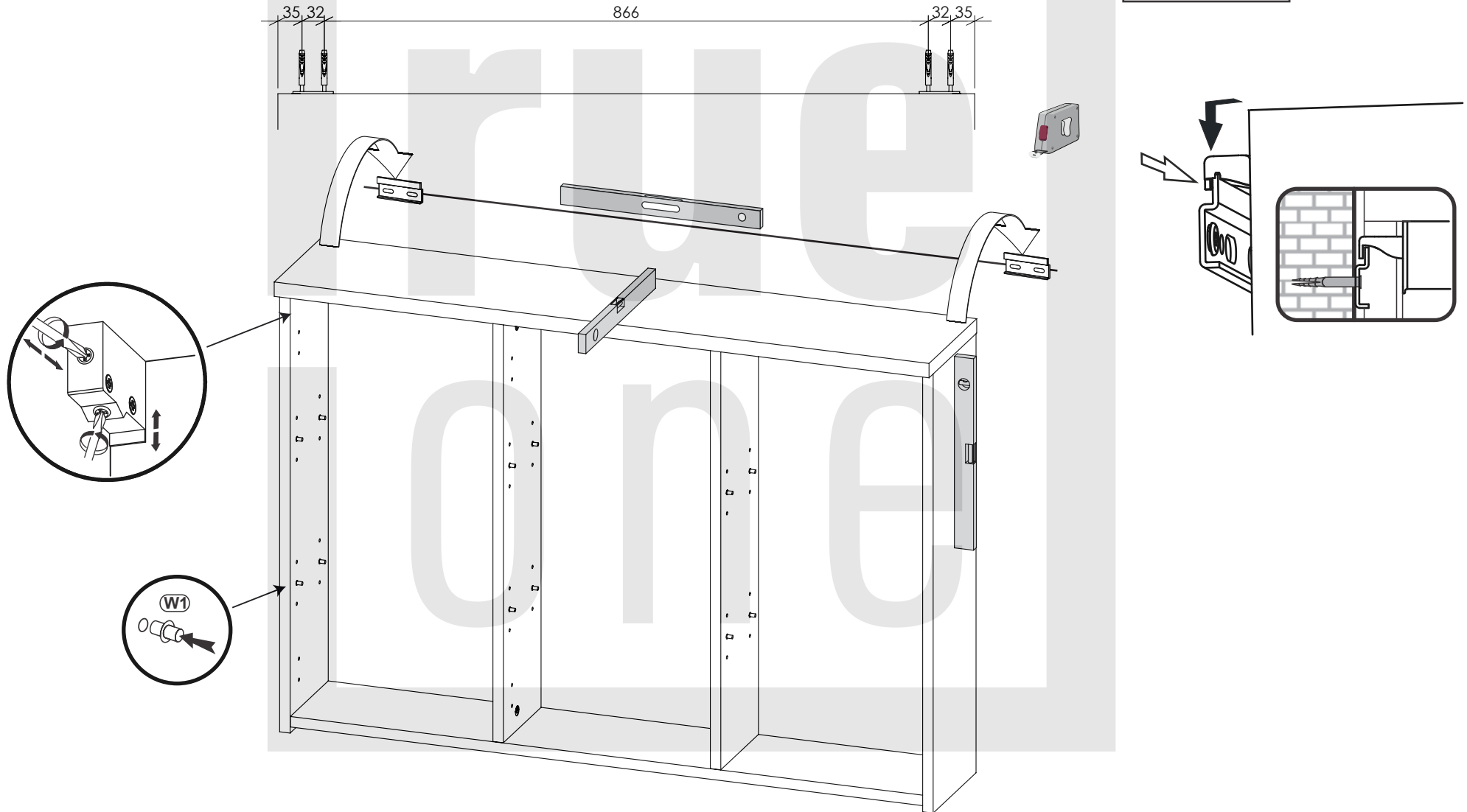
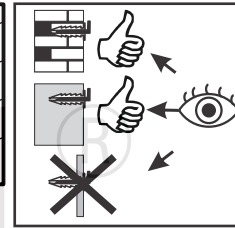
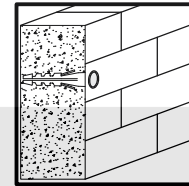
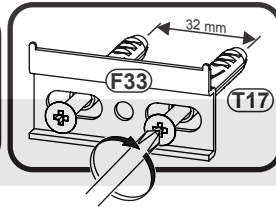
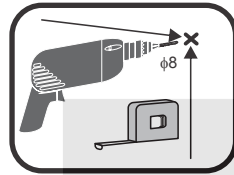
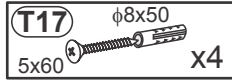
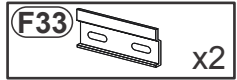

7

- Z2c x4
- S9 4x16 x12
- Z3c x2

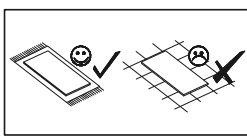
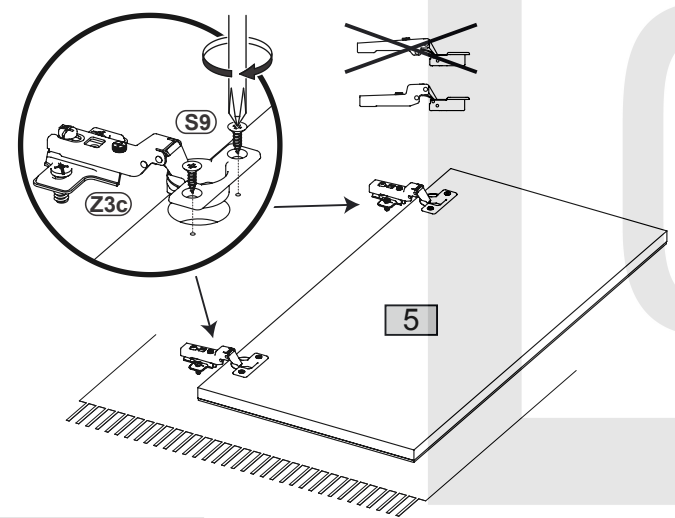
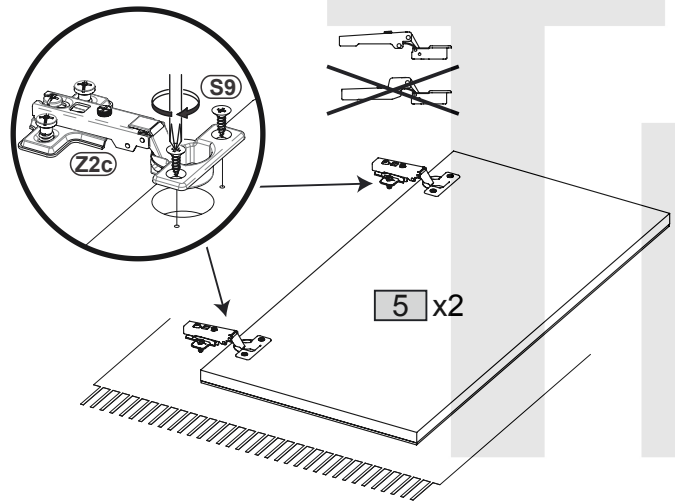

8

- C2 φ 20 x10

