

B1		ϕ 8x28	x4
T1			x4
M1			x4
C2		ϕ 20	x4

1

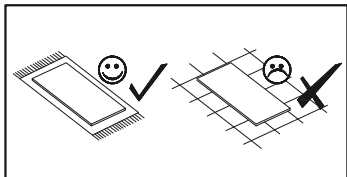

2

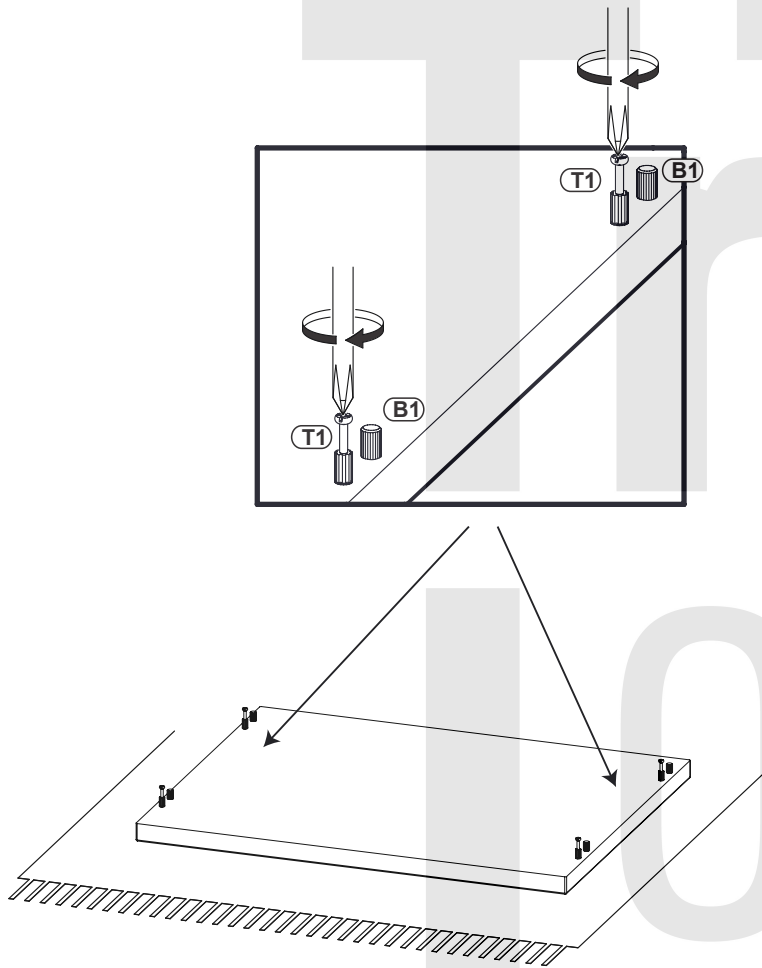
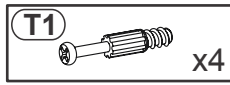
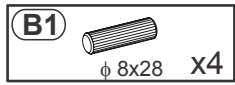
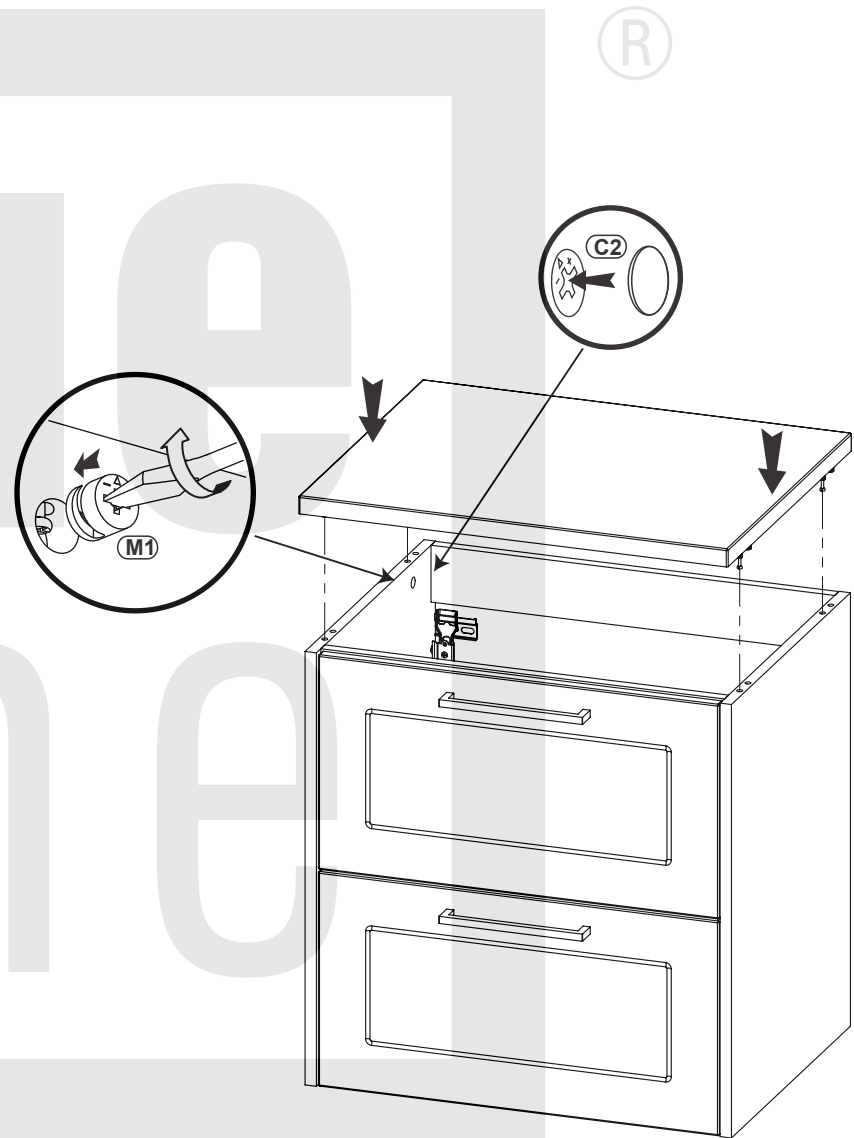
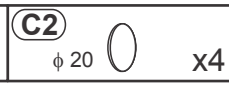

Typ 820