

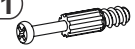

<b>B1</b>		x4
	$\phi$ 8x28	
<b>T1</b>		x4
<b>M1</b>		x4
<b>C2</b>		x4
	$\phi$ 20	

1



2

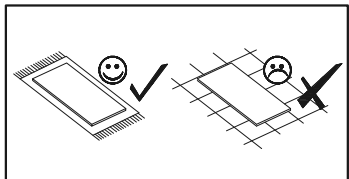
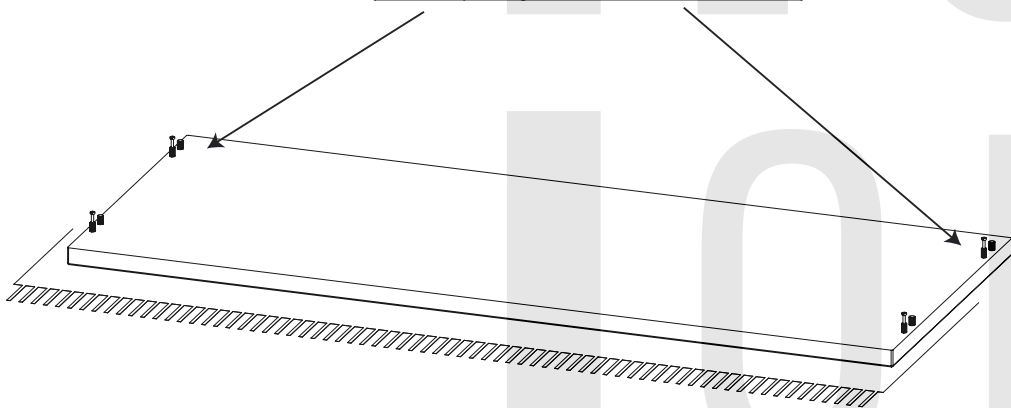
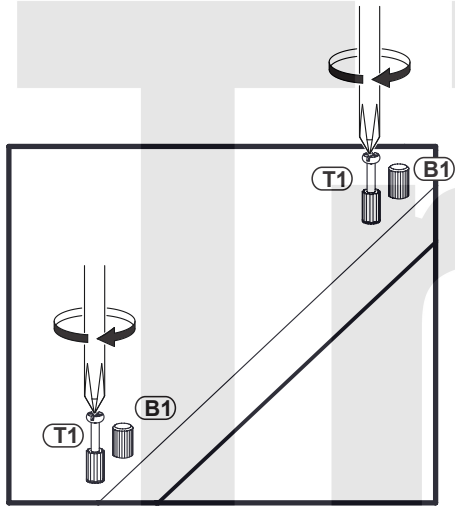
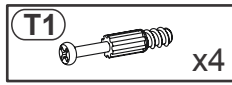
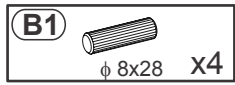
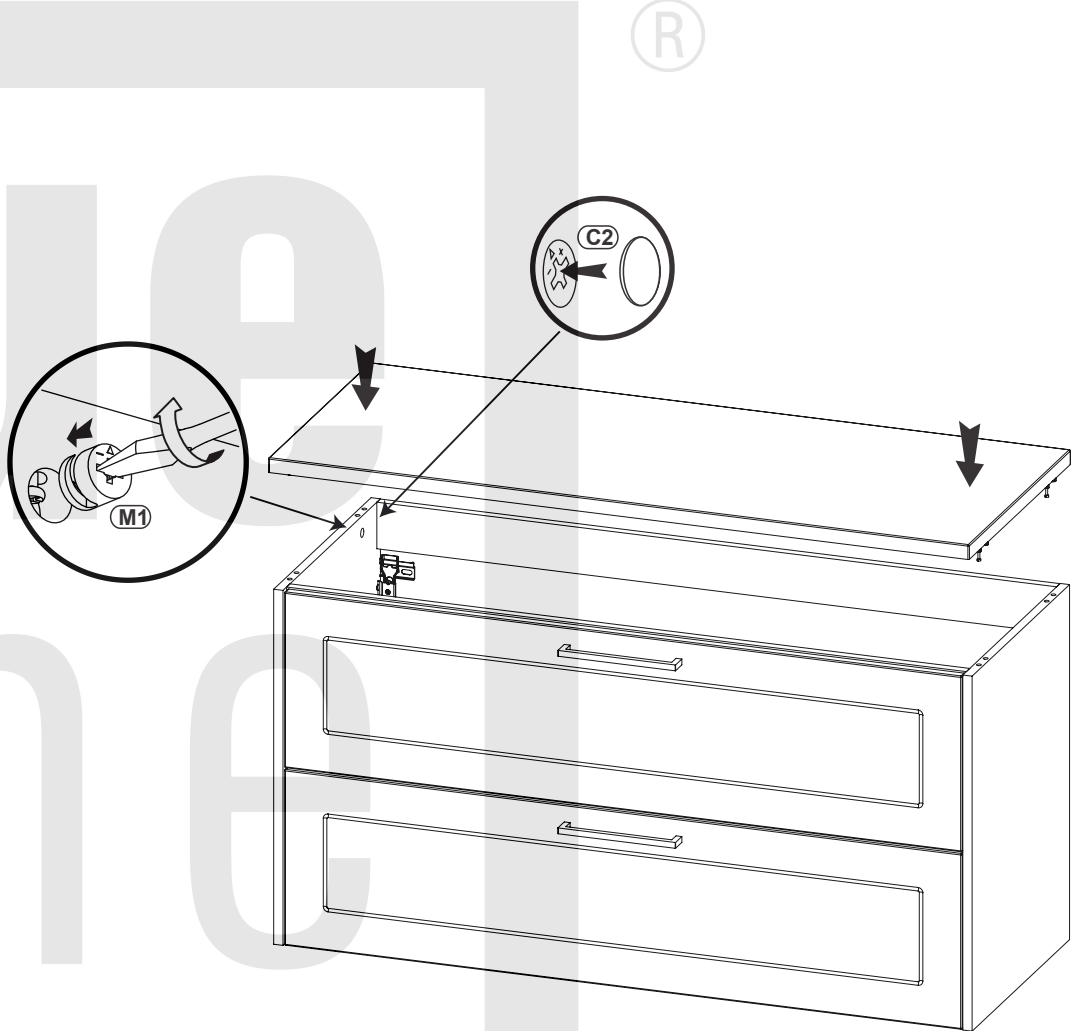
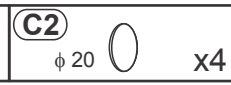

Typ 854