

# HAVANA CONCRETE 90-60

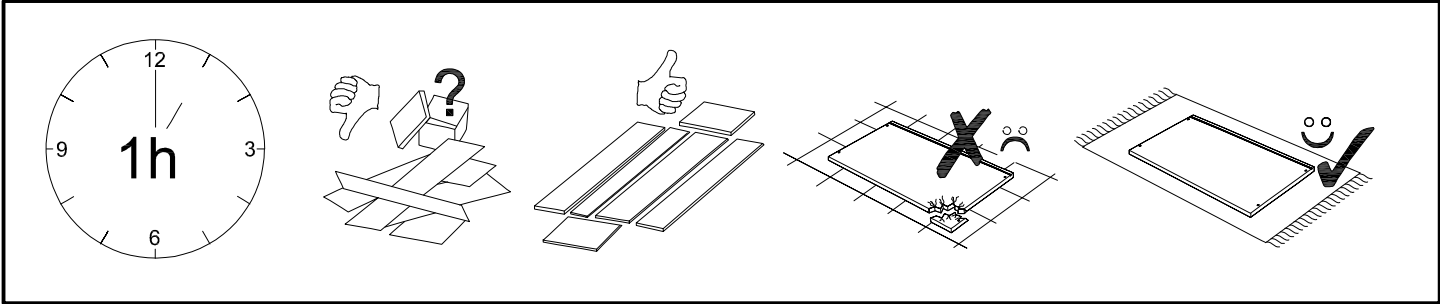

#	S	B	S	Q
1	470	605	22	1

