

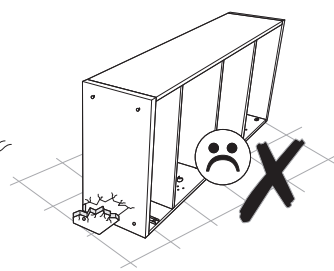

SANTA FE 89-140

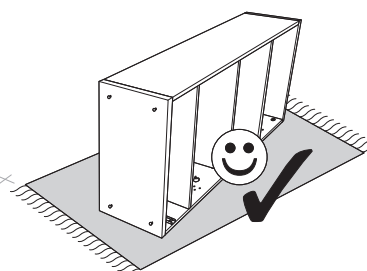

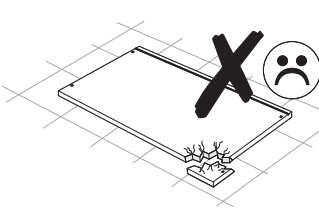
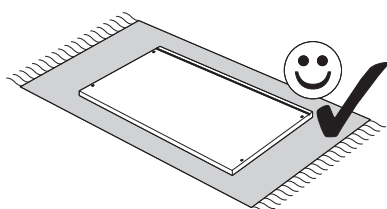
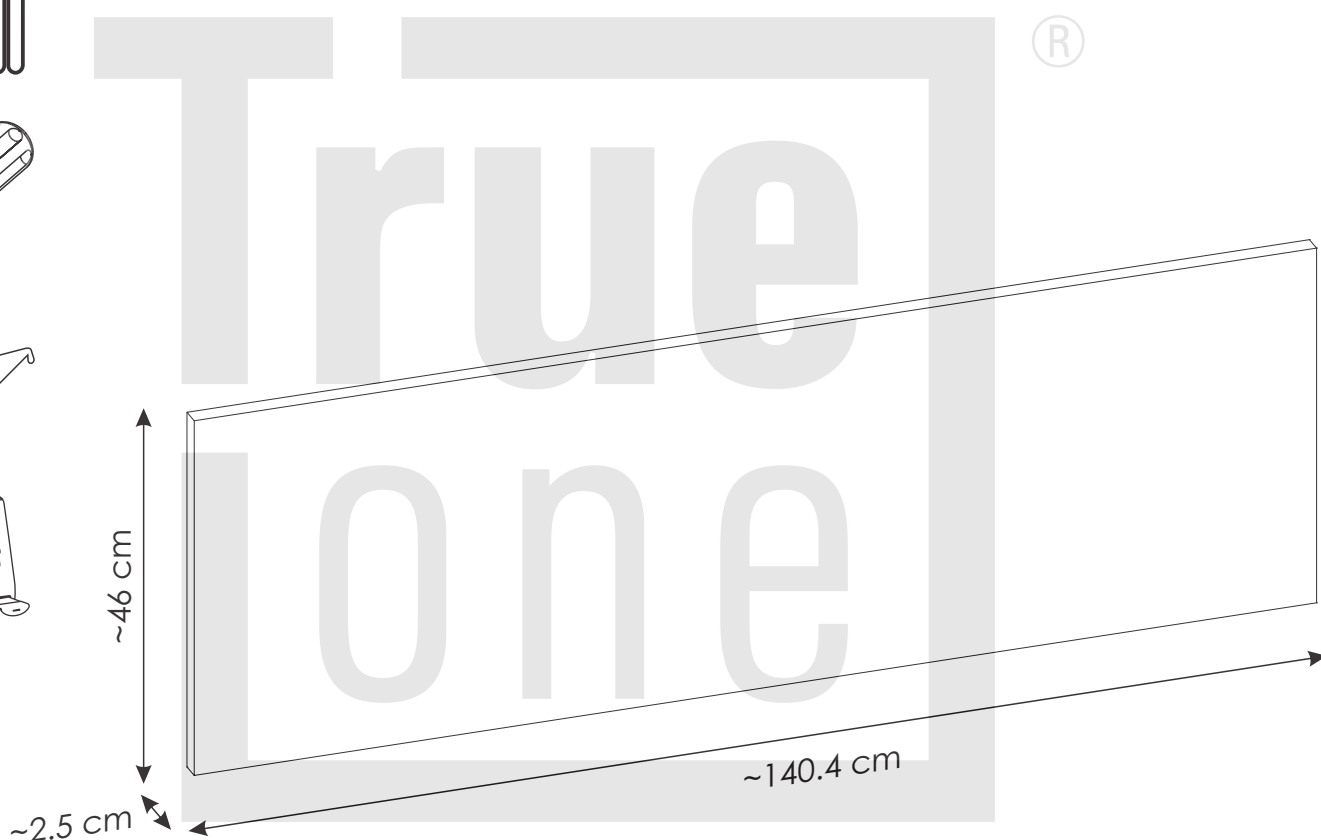
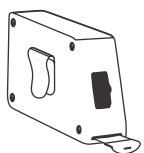
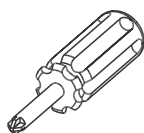
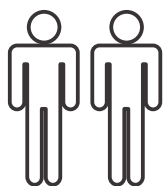
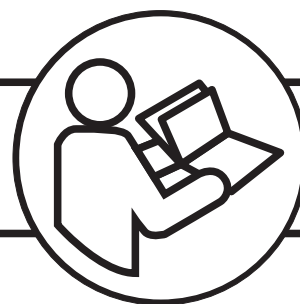
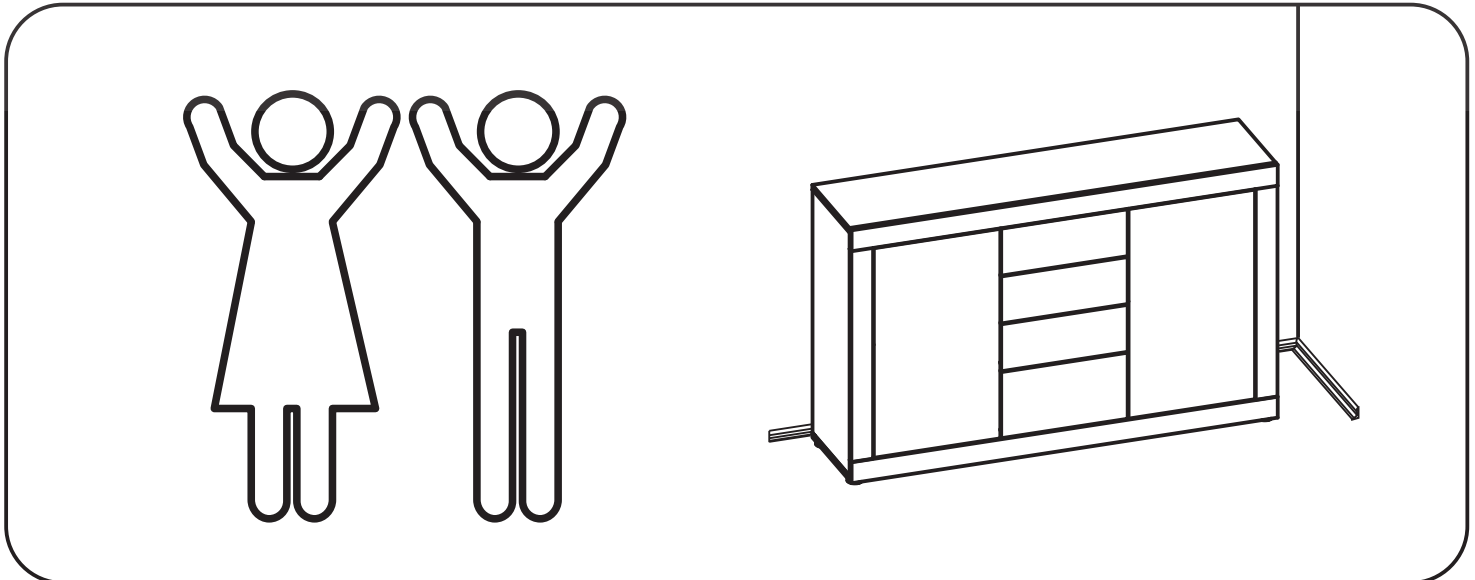
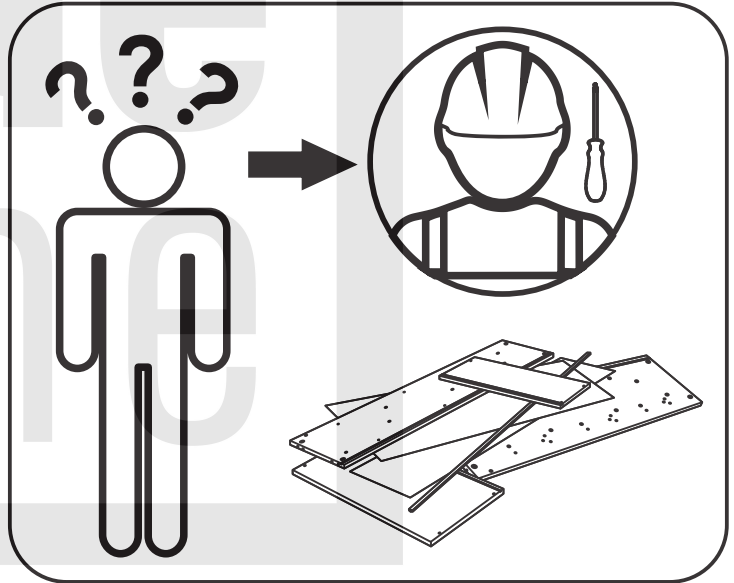
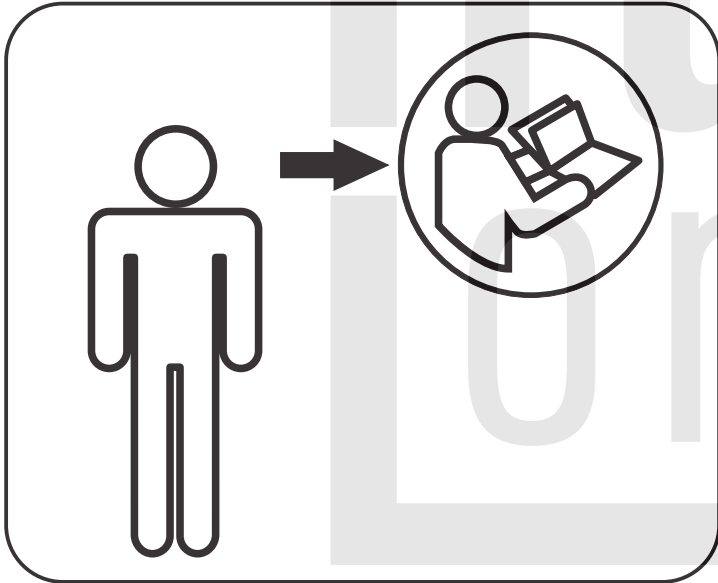
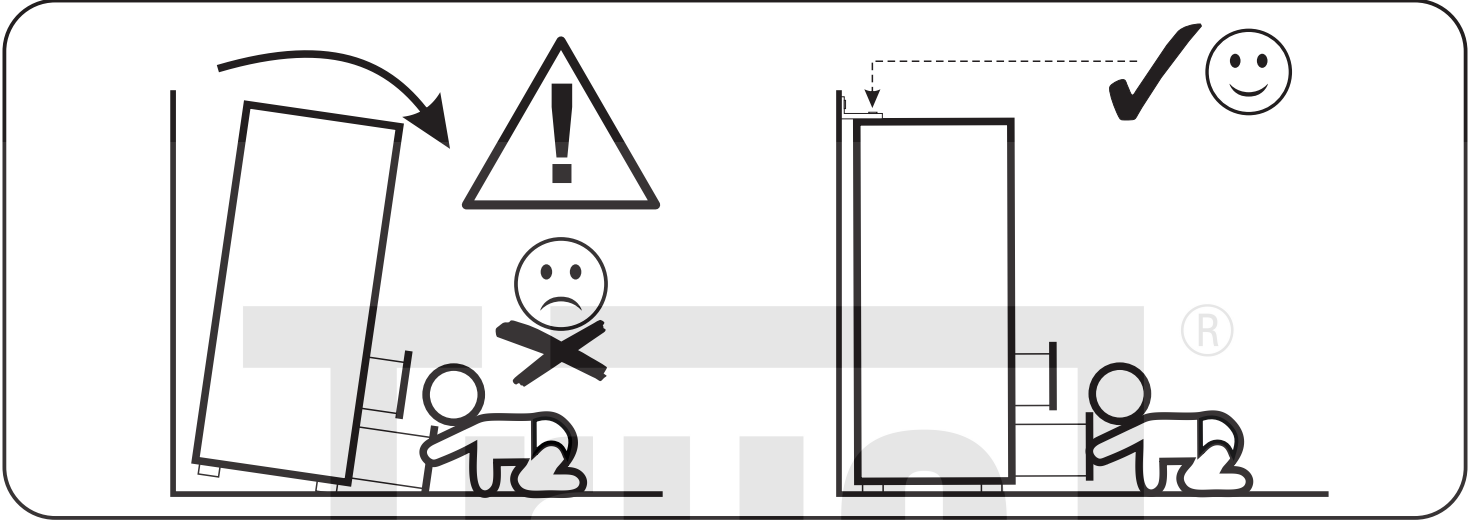
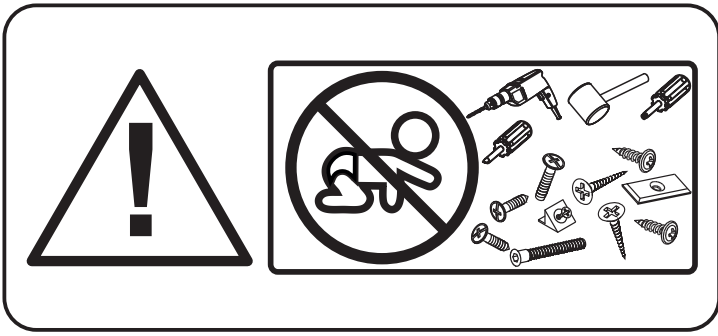
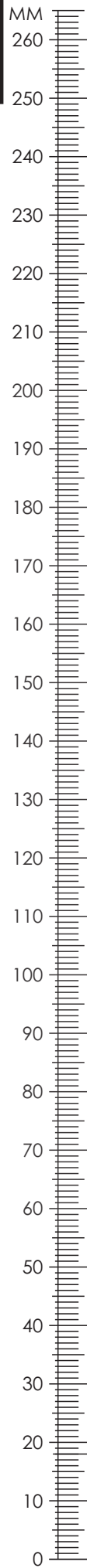

SANTA FE 89-140

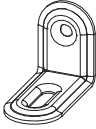

N5	3,5 x 16 mm	x36	Q8	x18
				

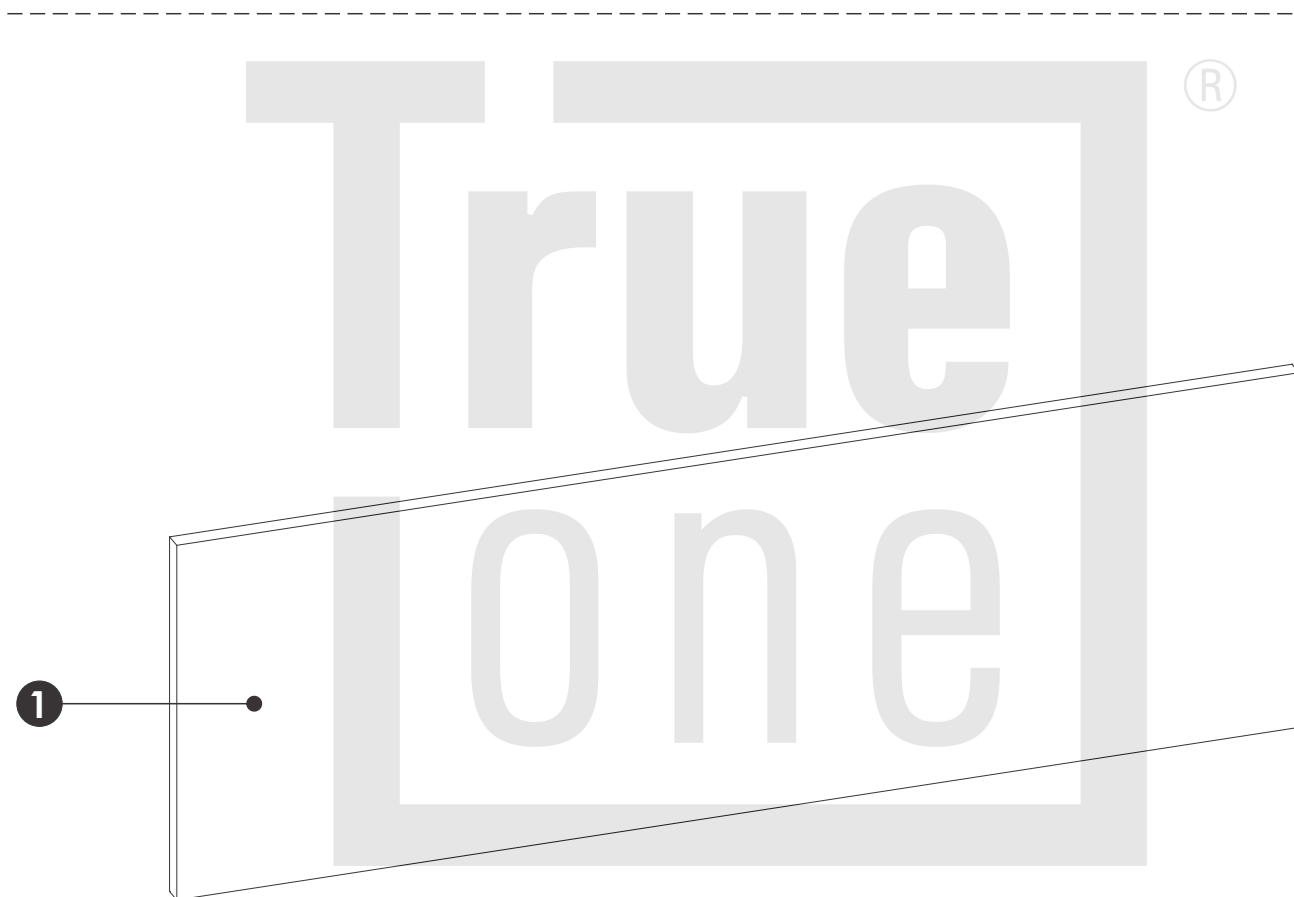

1	1404	460	25	x1	1/1
----------	------	-----	----	----	-----



1 ▶

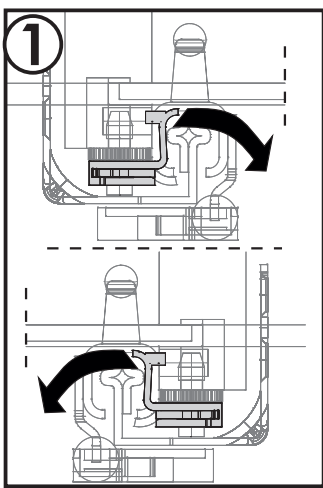

x2

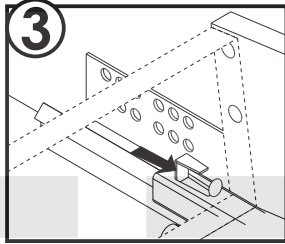
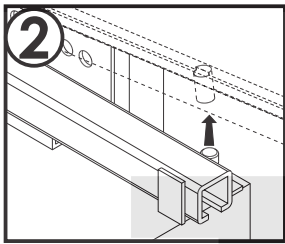
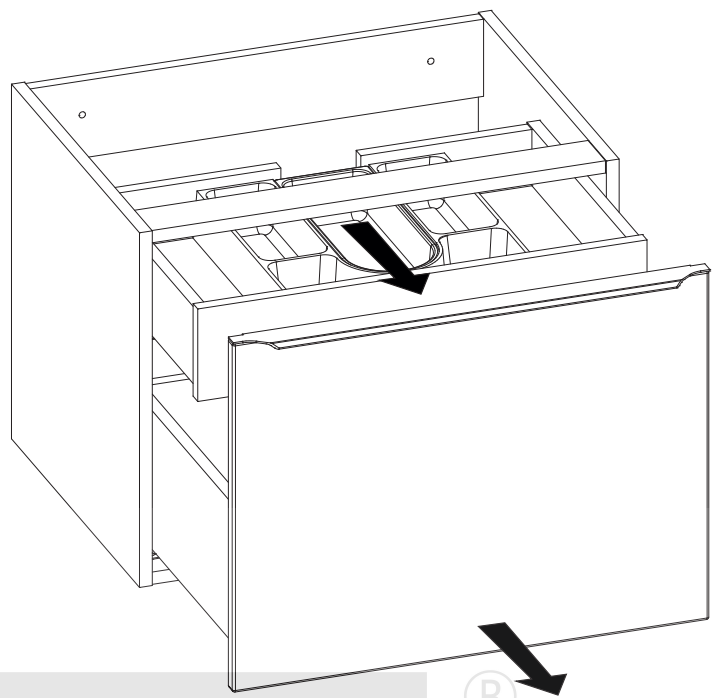

2 ▶

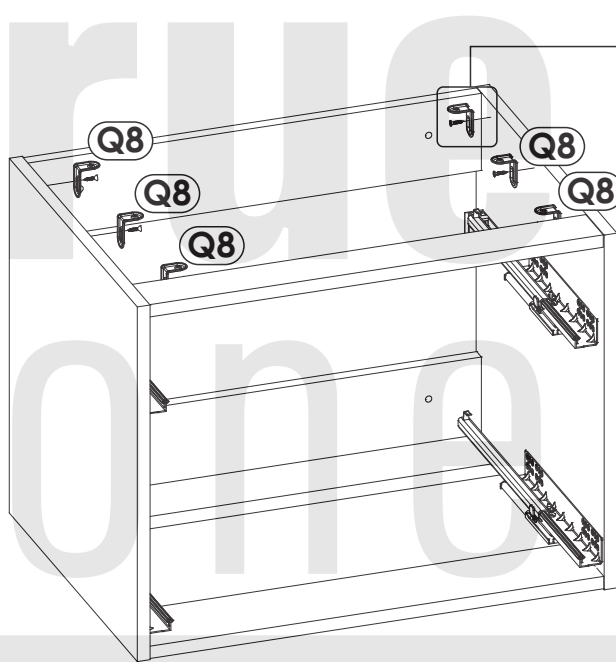
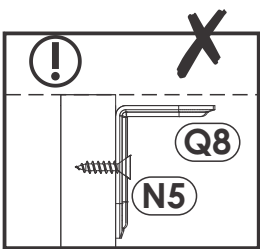
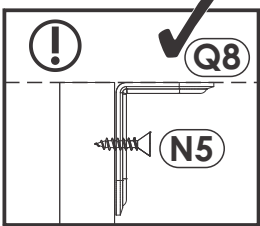

x6

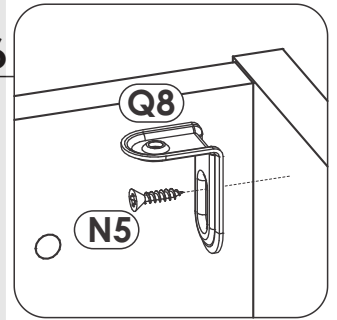

x2

3 ▶

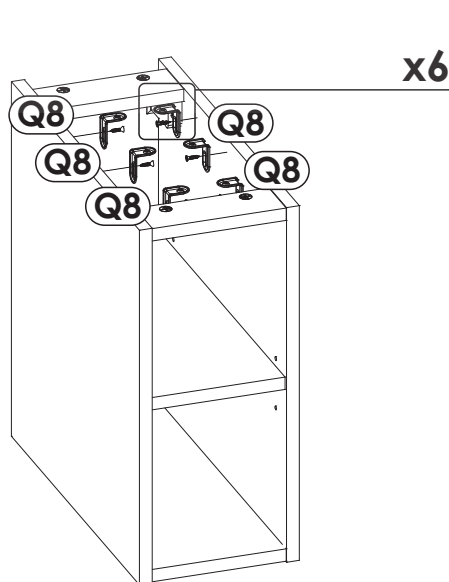
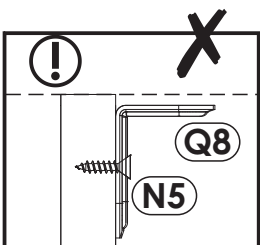
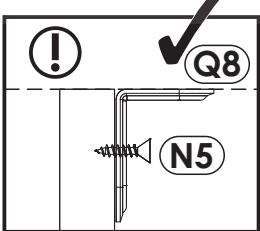

x6

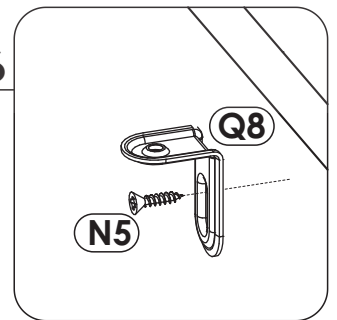

4 ▶ A.

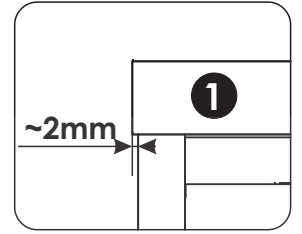
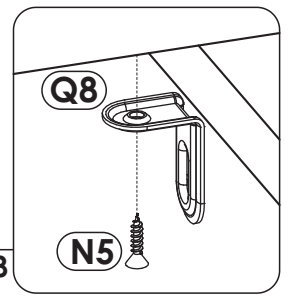
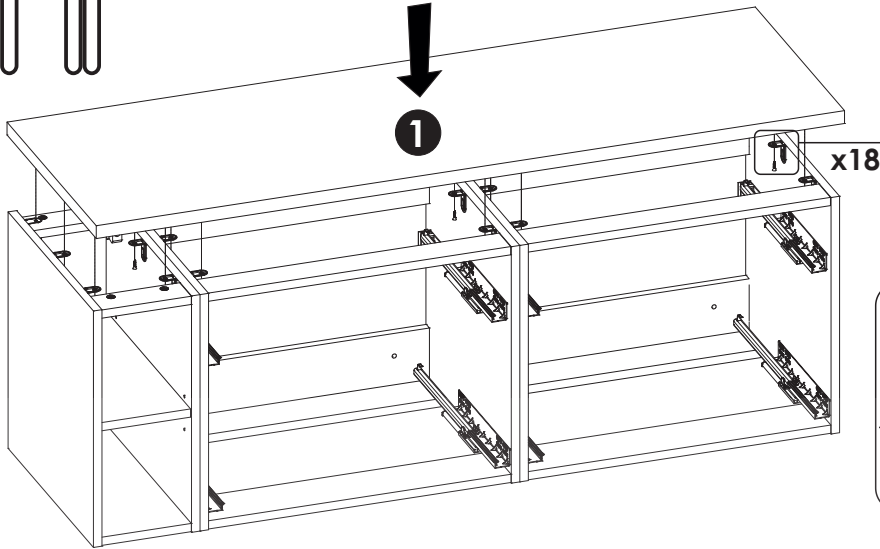
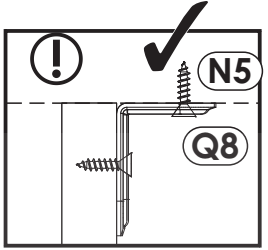
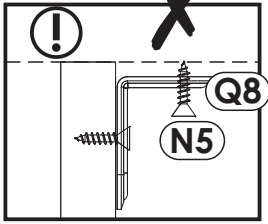
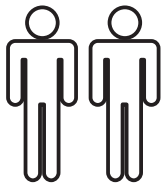

B.

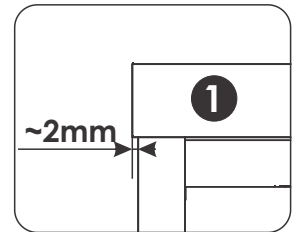
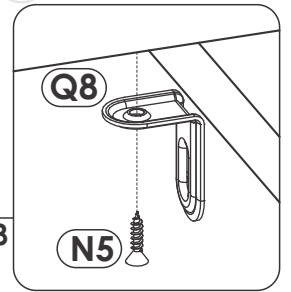
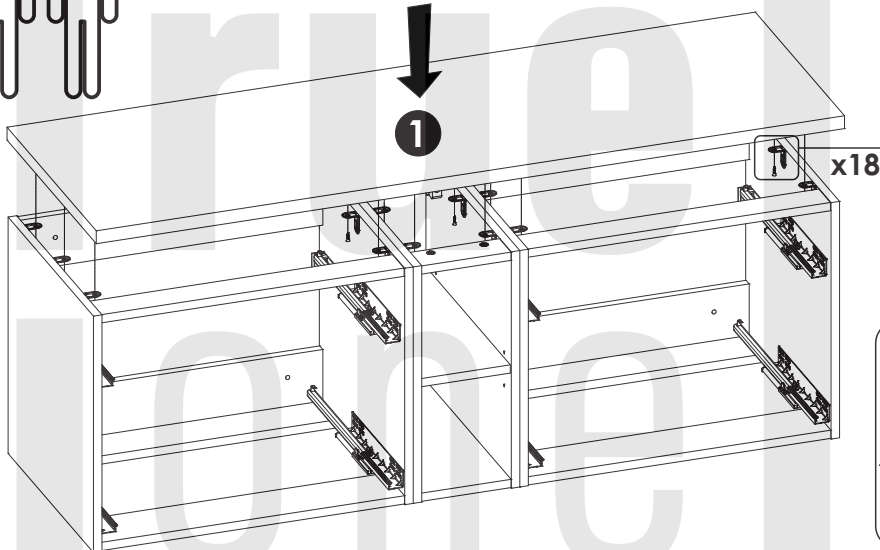
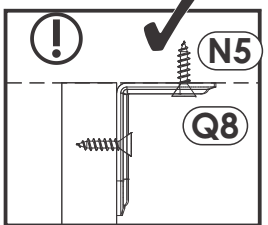
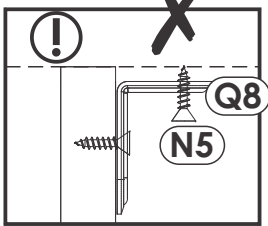
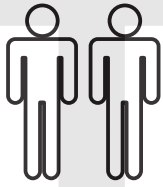

C.

