

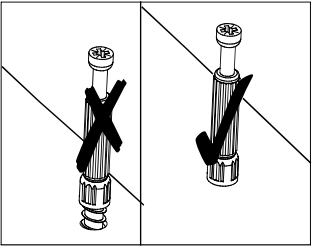

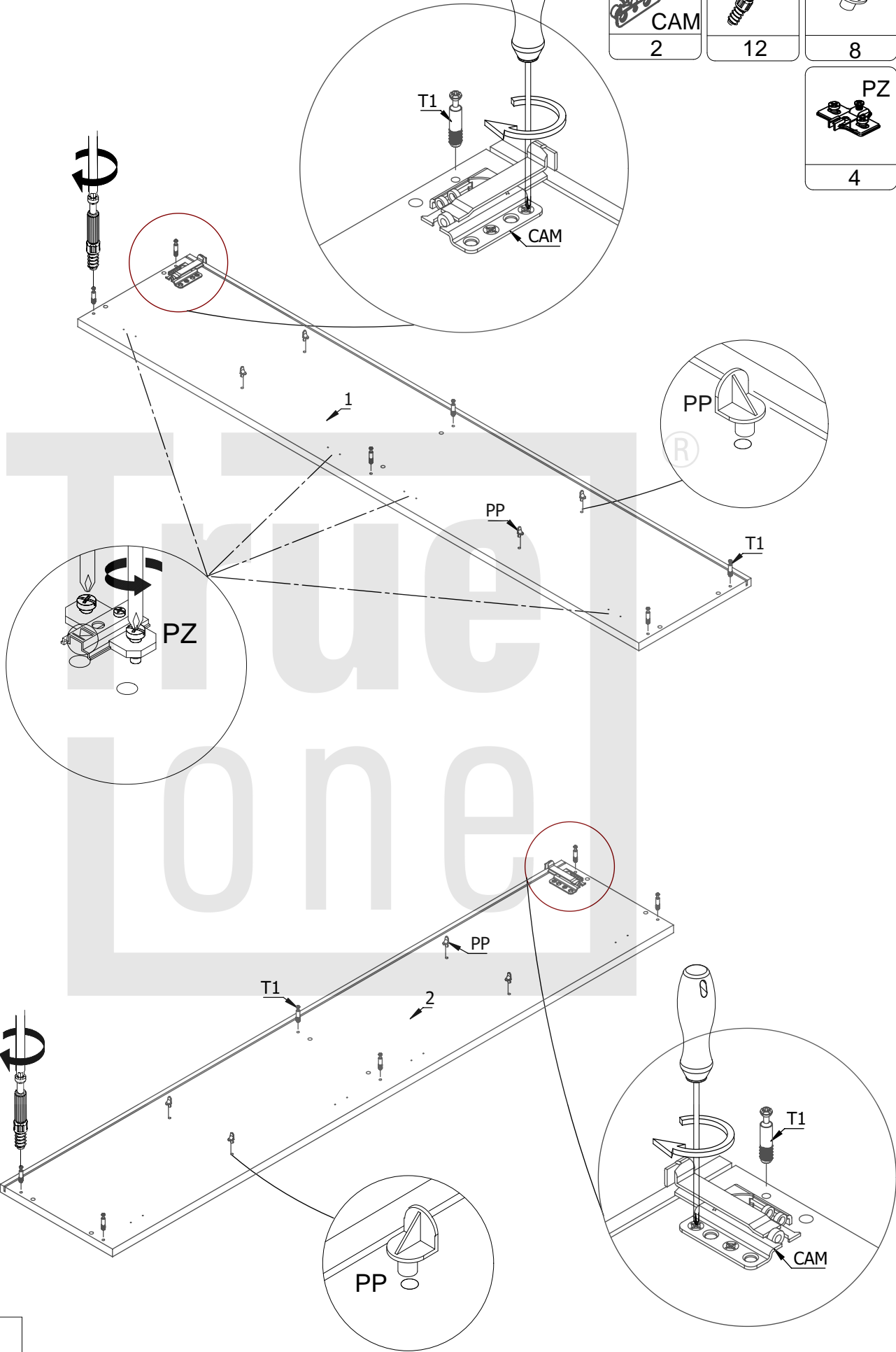

<p>KR 10x80</p> <p>4</p>	<p>STB</p> <p>8</p>	<p>CAM</p> <p>2</p>	<p>x</p> <p>12</p>	<p>ZA</p> <p>2</p>	<p>UM</p> <p>2</p>	<p>ZP</p> <p>PZ</p>
<p>K30</p> <p>12</p>	<p>T1</p> <p>12</p>	<p>M1</p> <p>12</p>	<p>PP</p> <p>8</p>	<p>W3,5x16</p> <p>4</p>	<p>W4x16</p> <p>8</p>	
<p>PZ</p> <p>4</p>	<p>ZP</p> <p>4</p>					

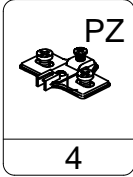

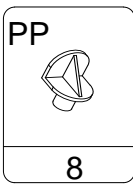
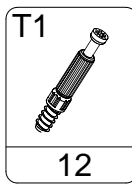
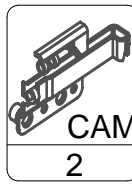
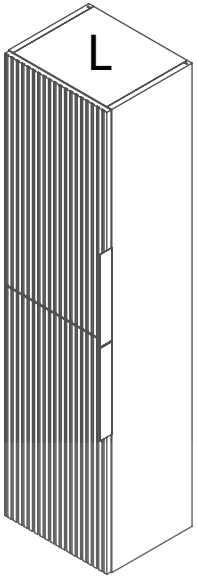
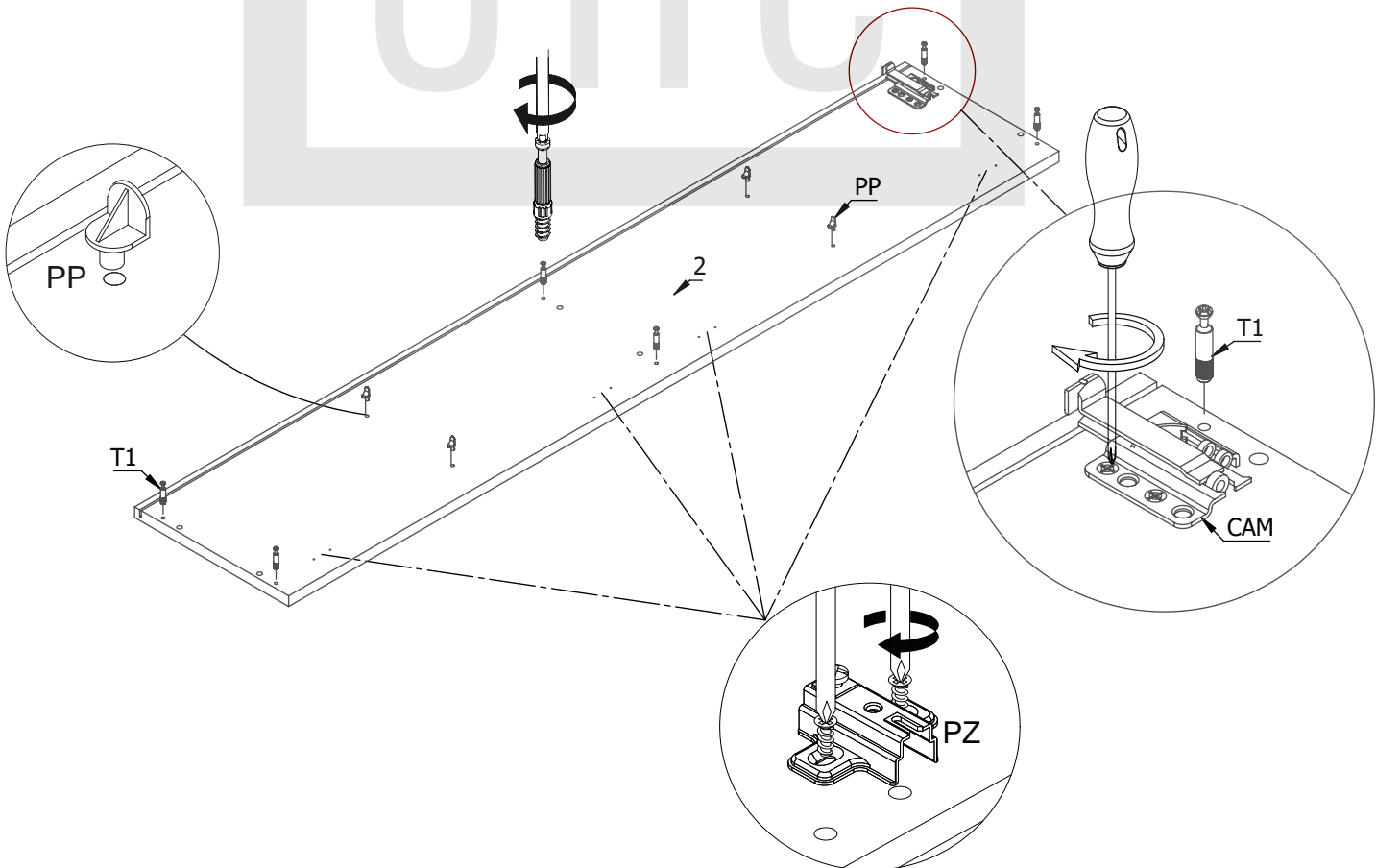
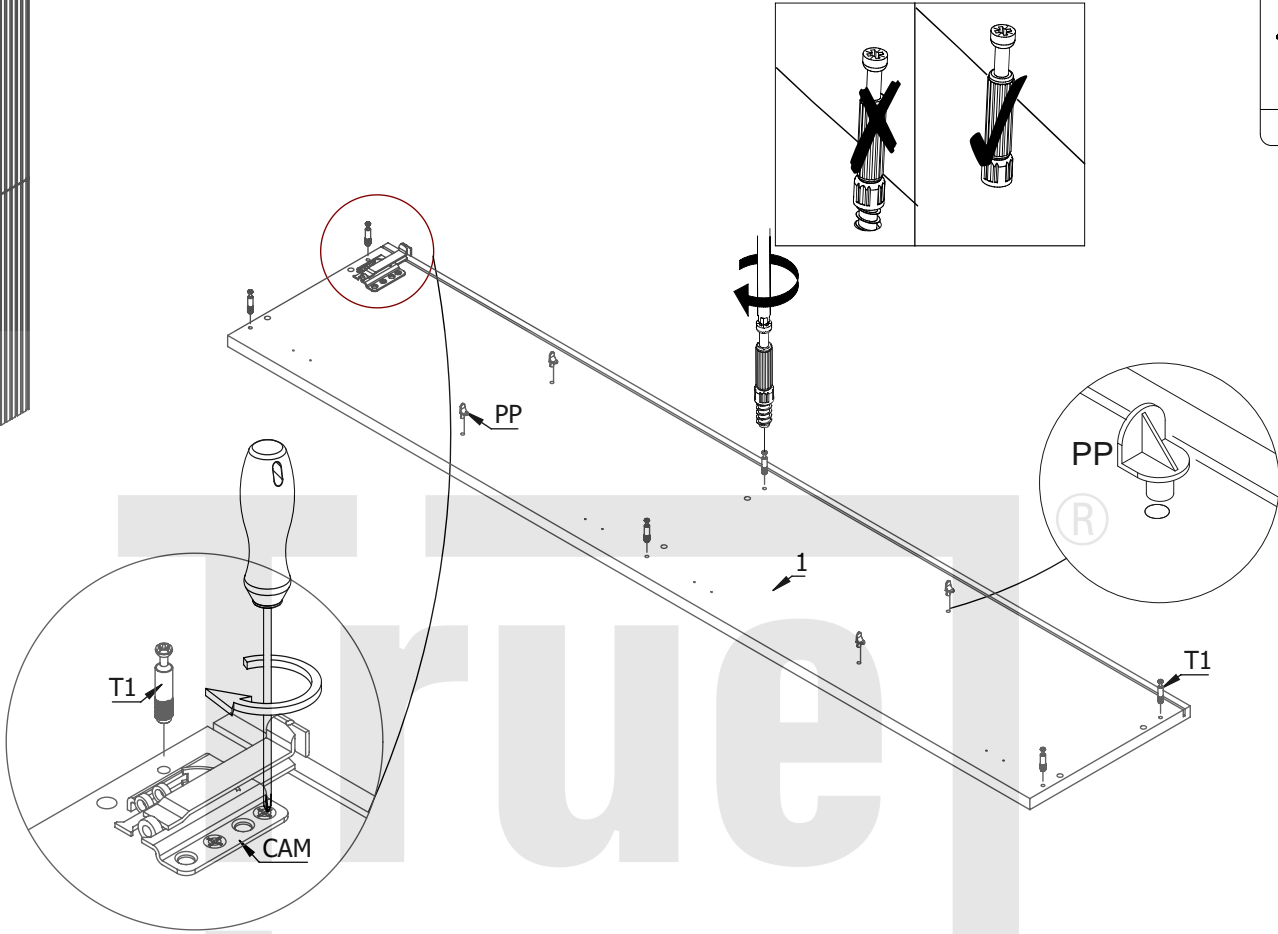
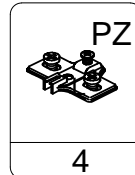
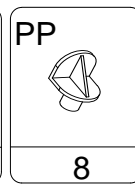
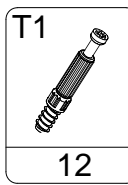
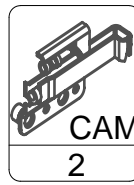
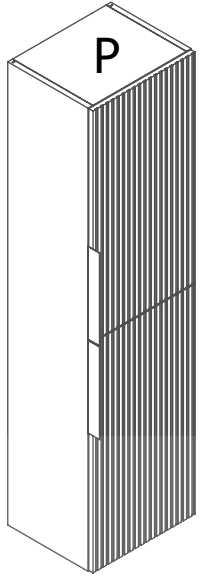

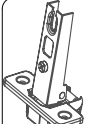
K30  12	M1  12	ZP  4	W4x16  8
---	--	---	--

