

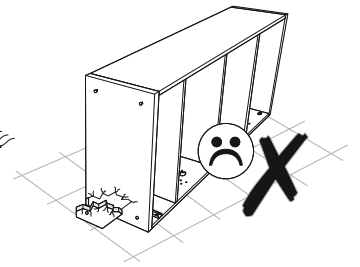

TYP 004-89-120-B

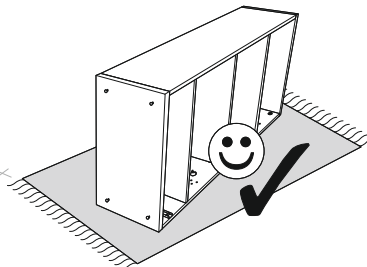

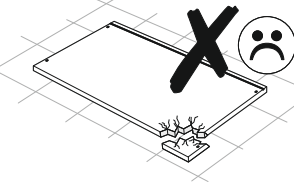
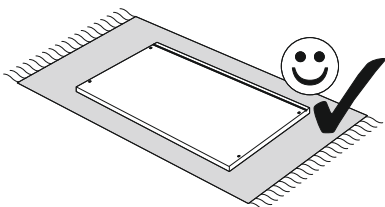
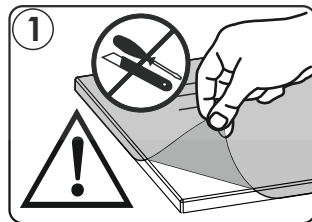
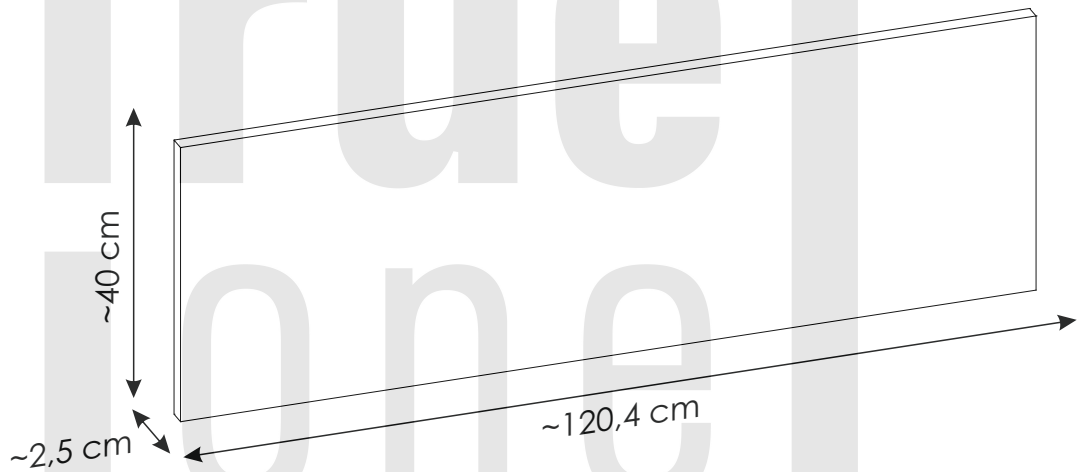
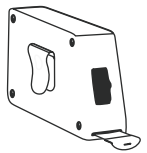
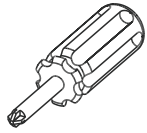
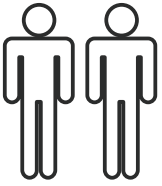
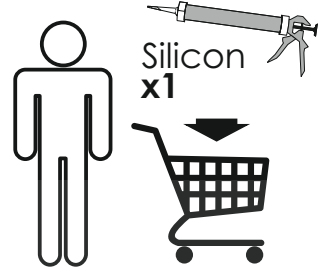
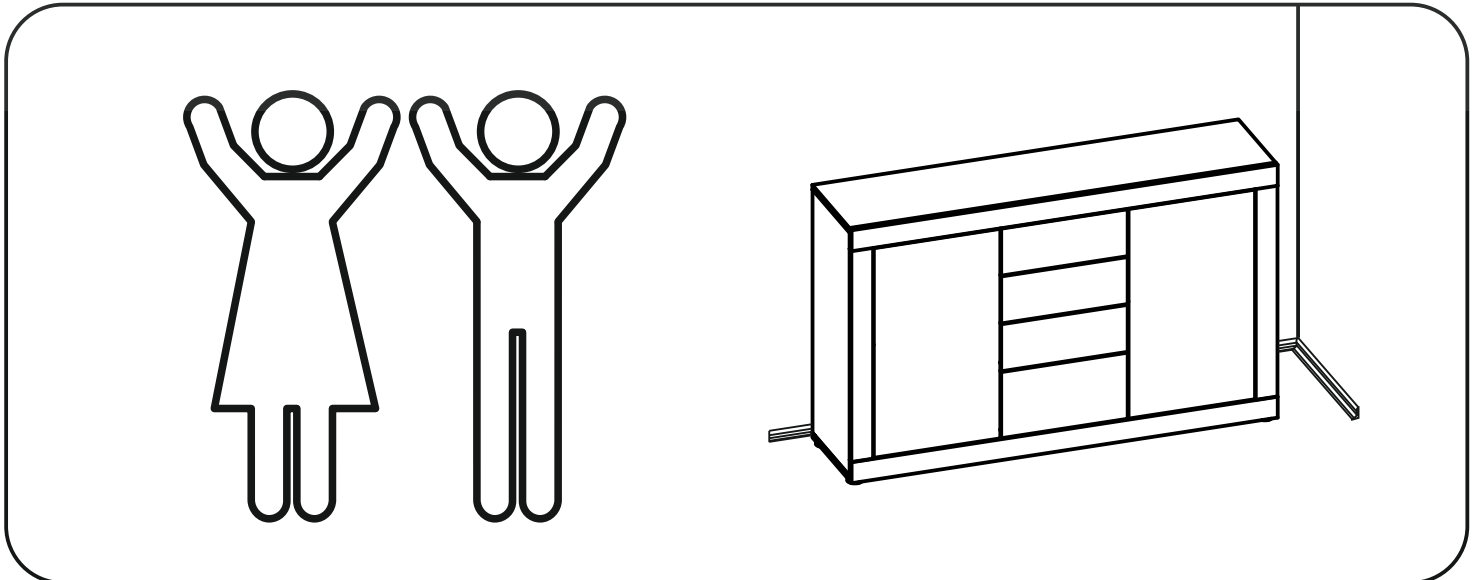
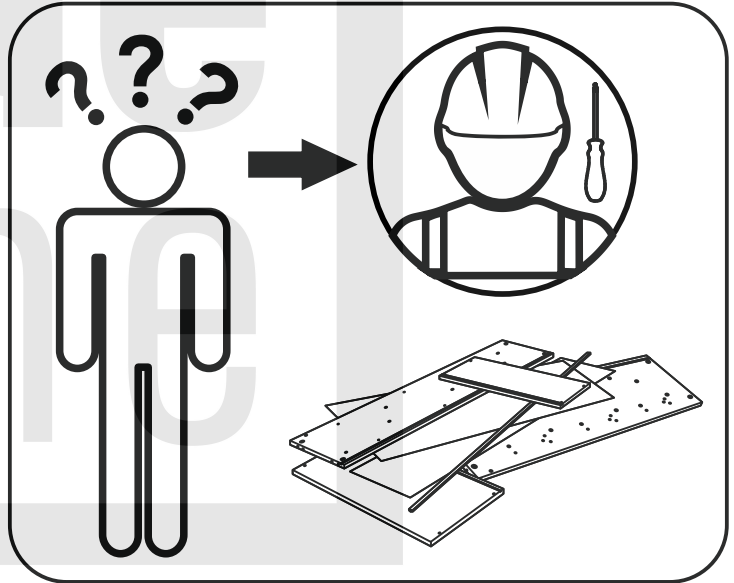
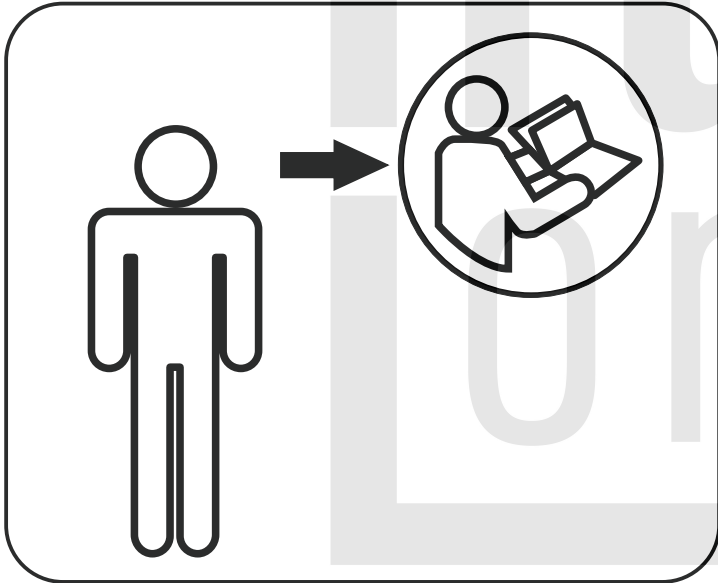
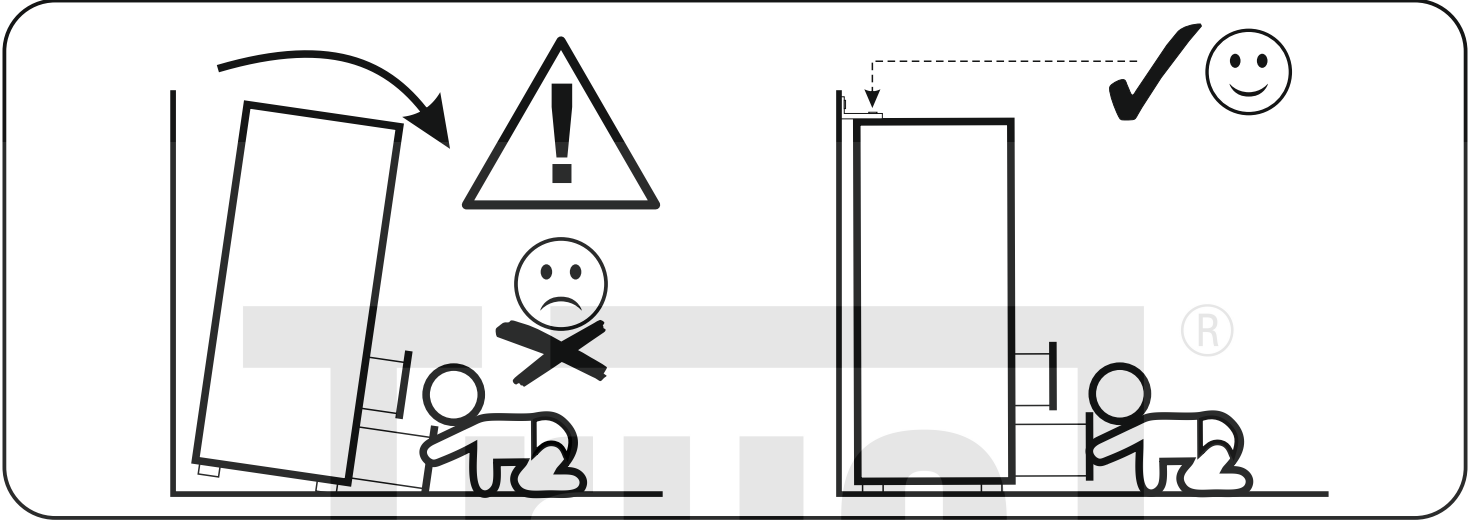
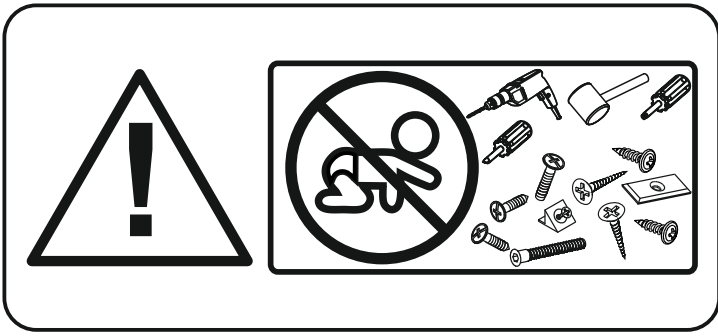
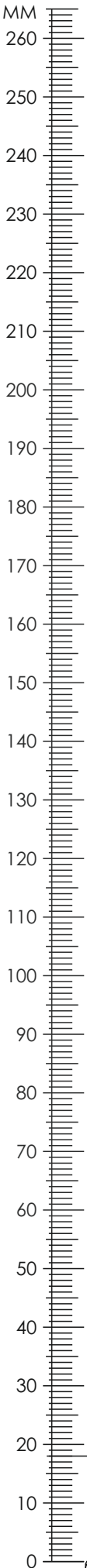

TYP 004-89-120-B

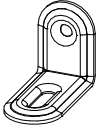

N5	3,5 x 16 mm	x24	Q8	x12
				

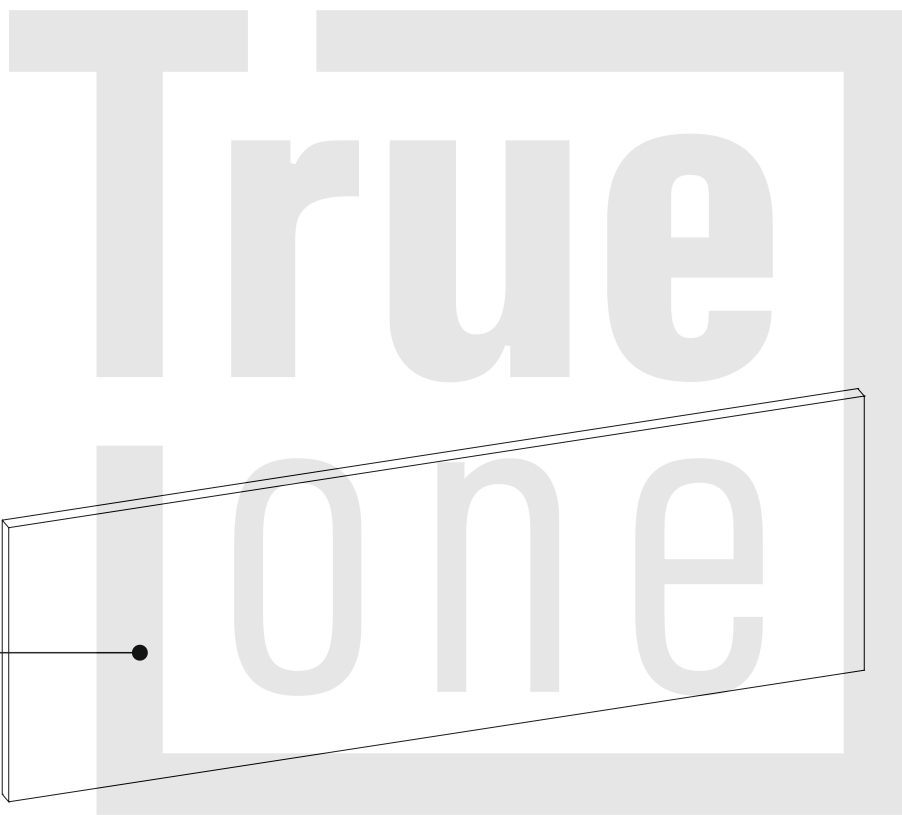

1

1	1204	400	25	x1	1/1
----------	------	-----	----	----	-----



1 ▶

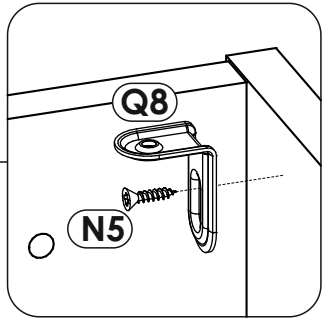
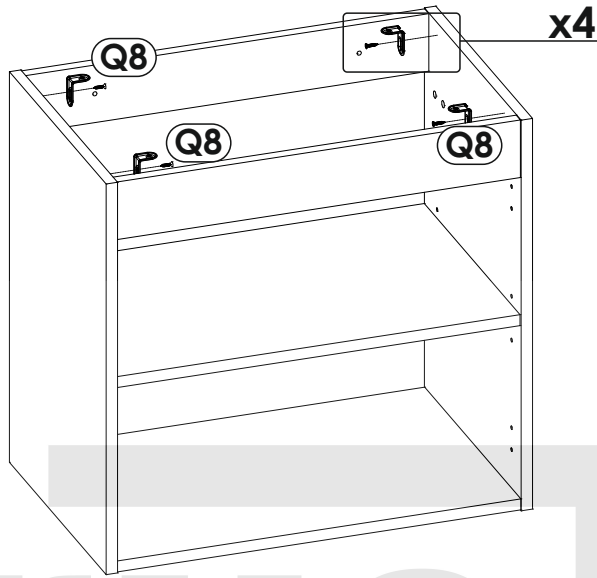
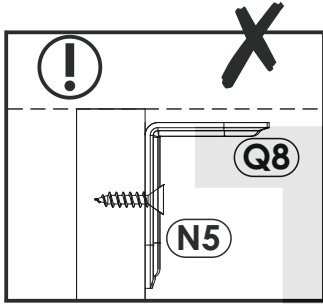
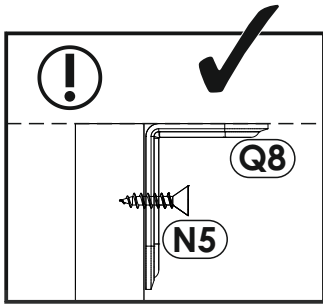

x2

2 ▶

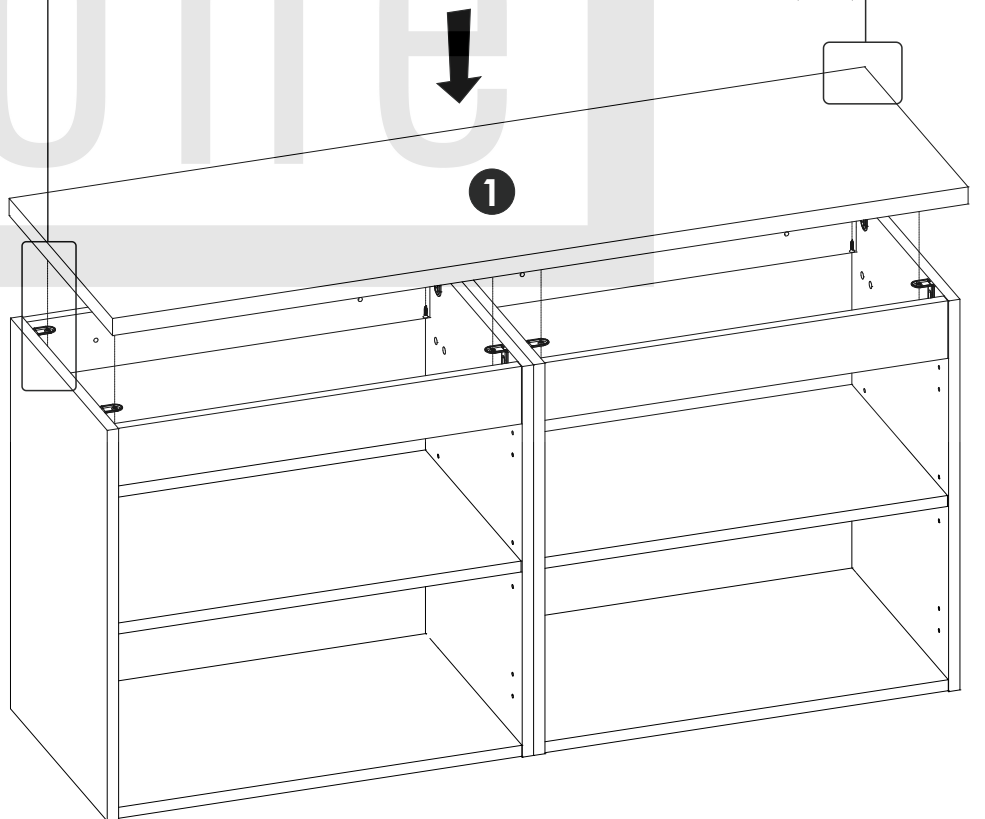
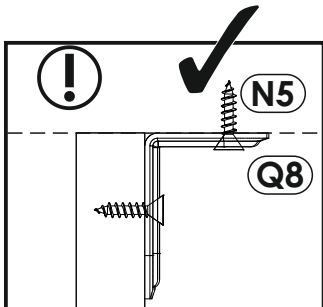
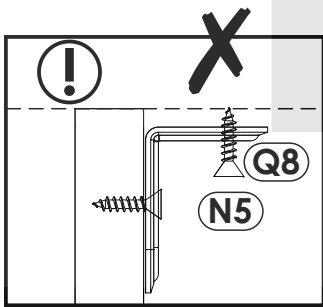
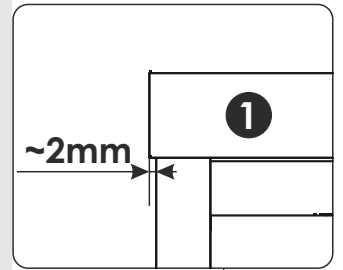
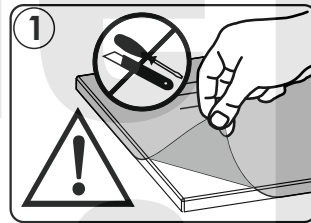
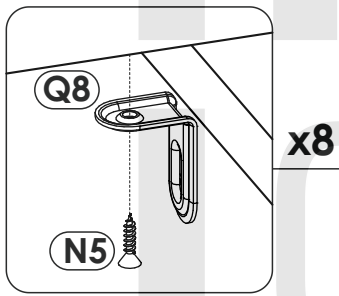

3 ▶

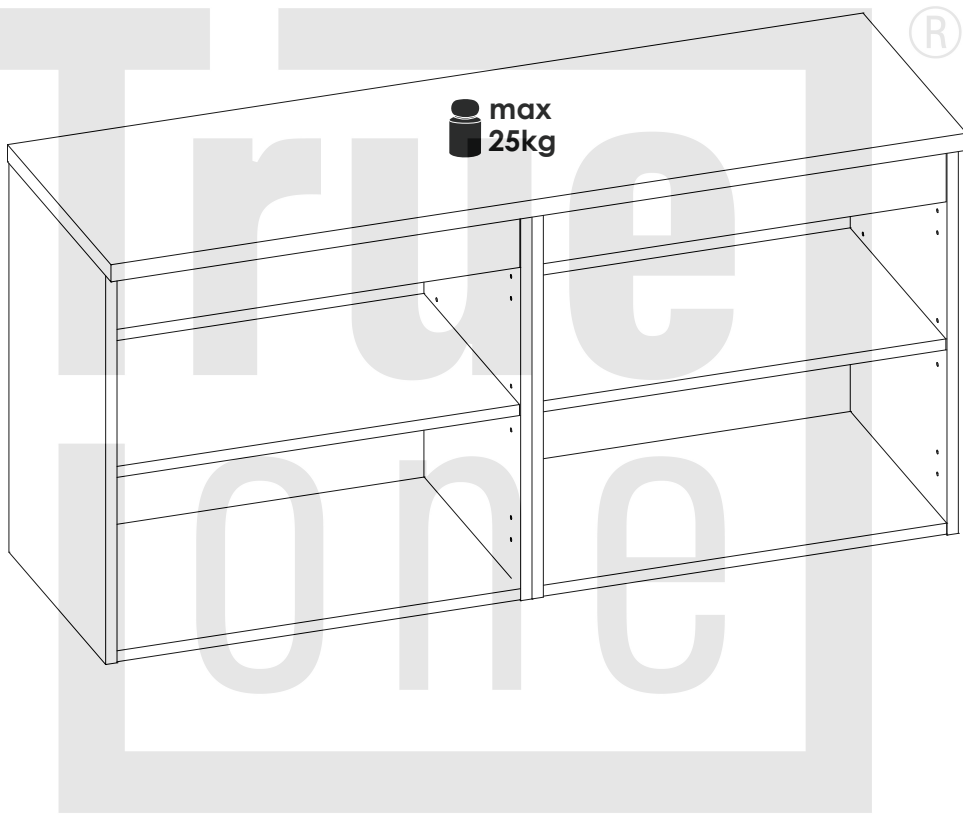

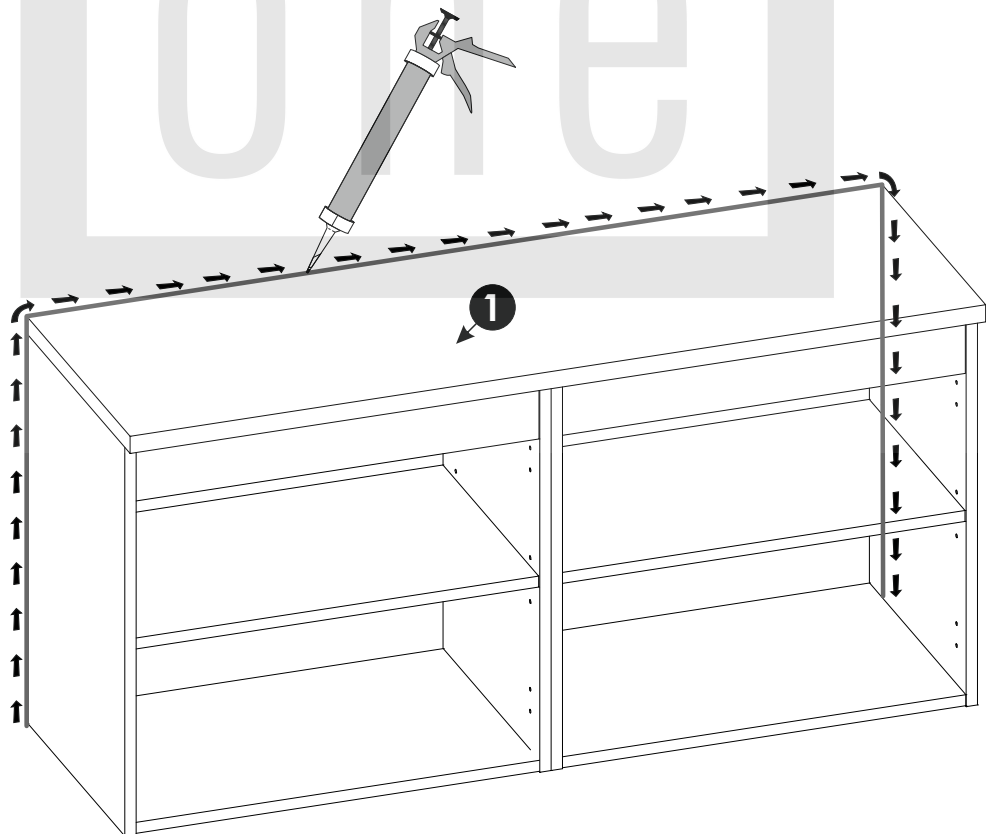
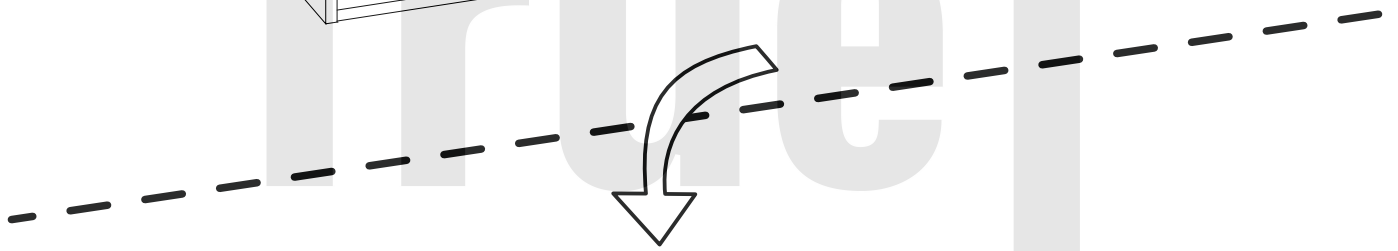
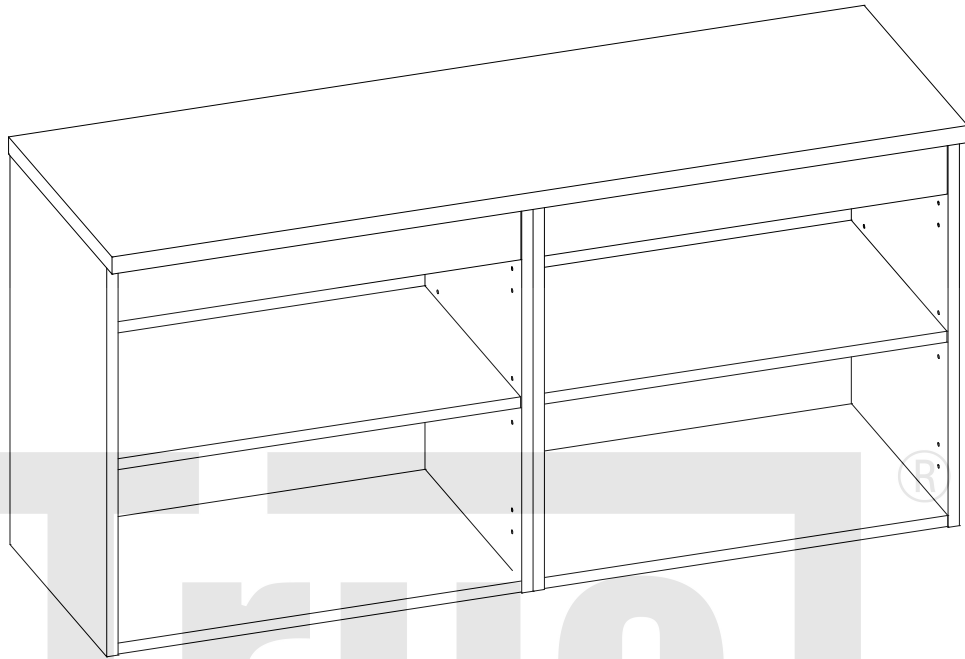
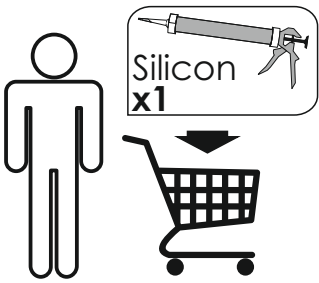

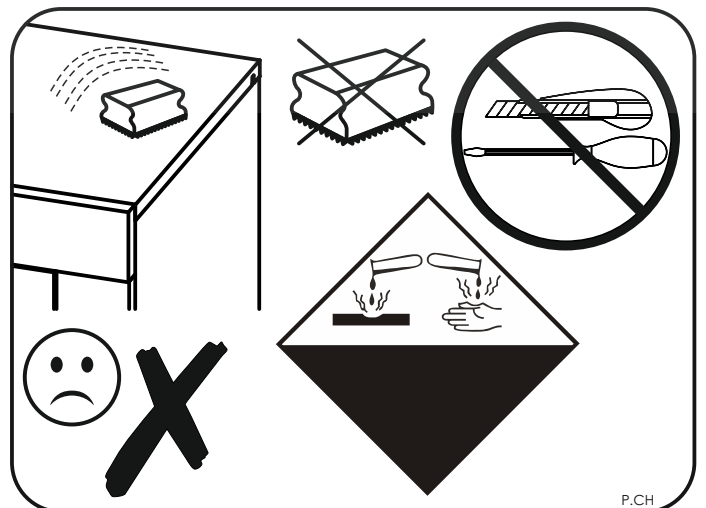
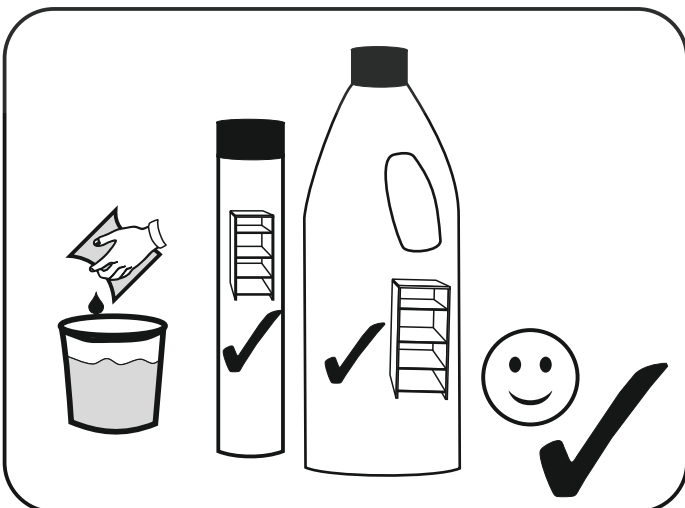
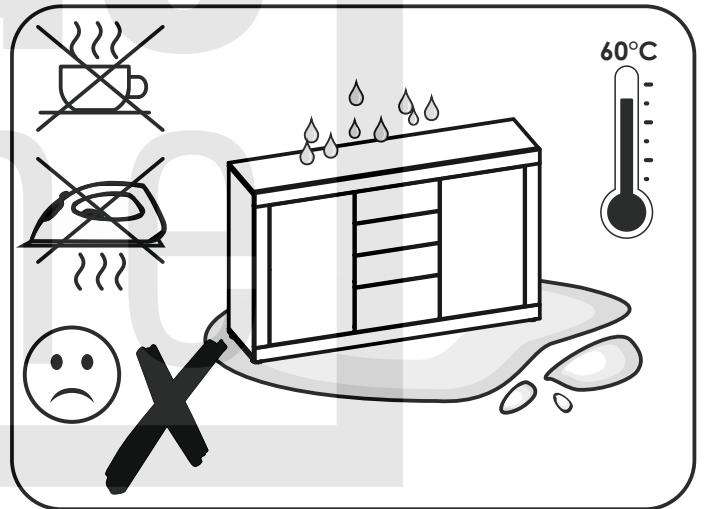
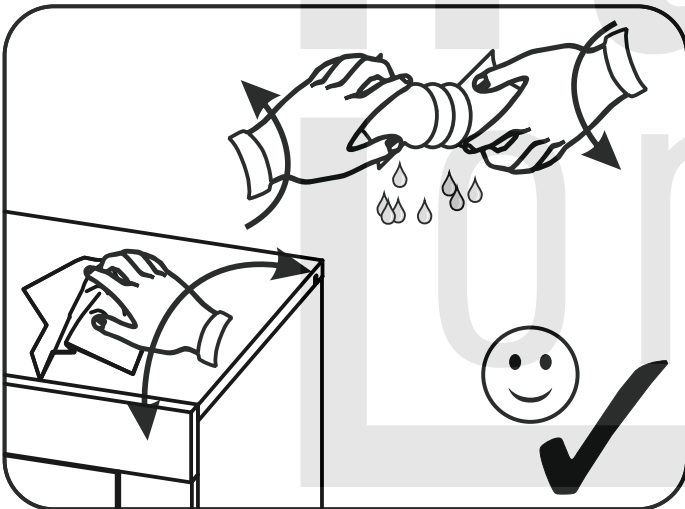
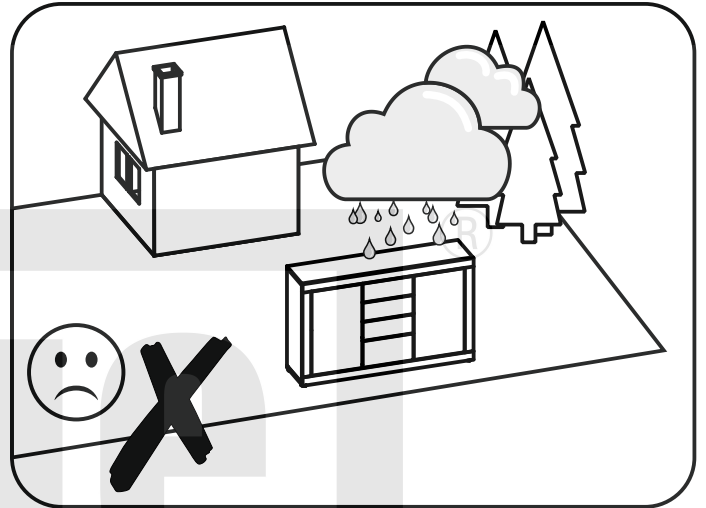
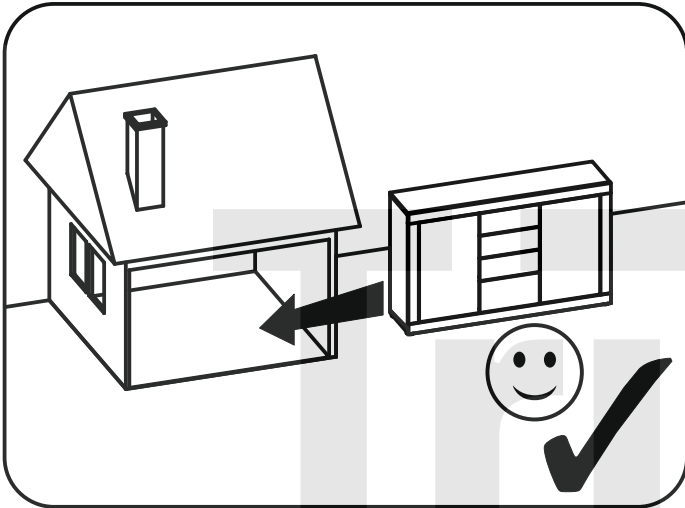
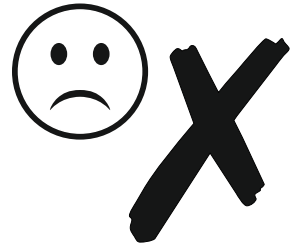

P.CH