

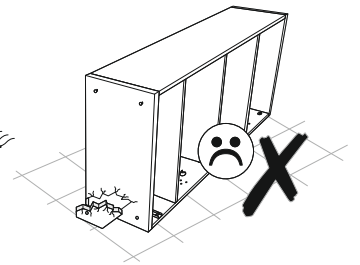

TYP 004-89-140-B

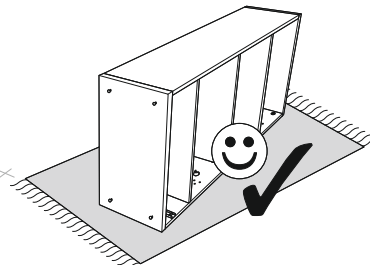

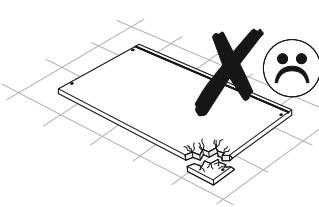
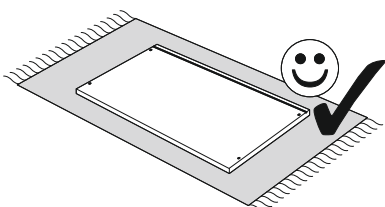
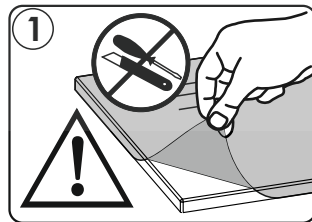
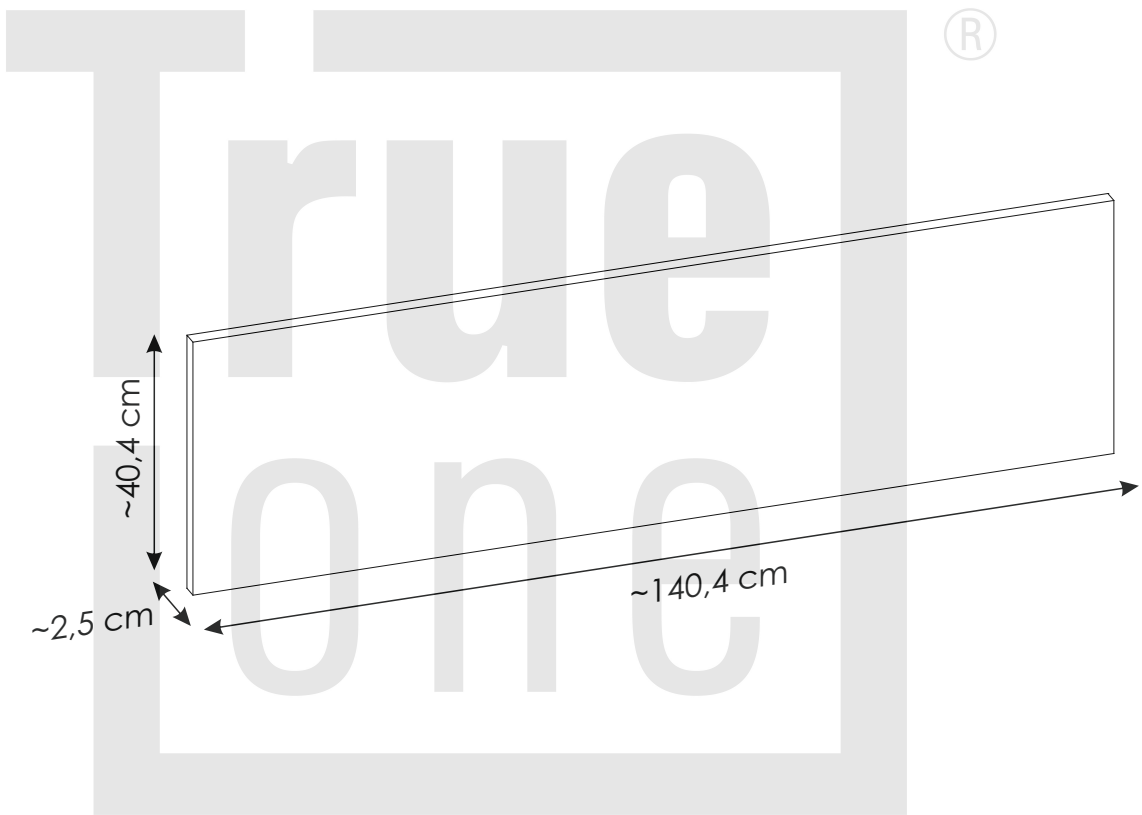
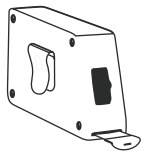
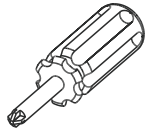
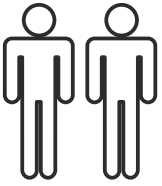
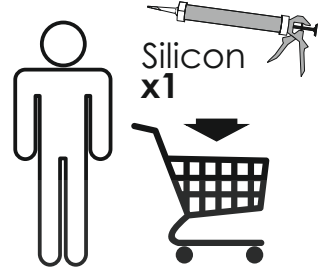
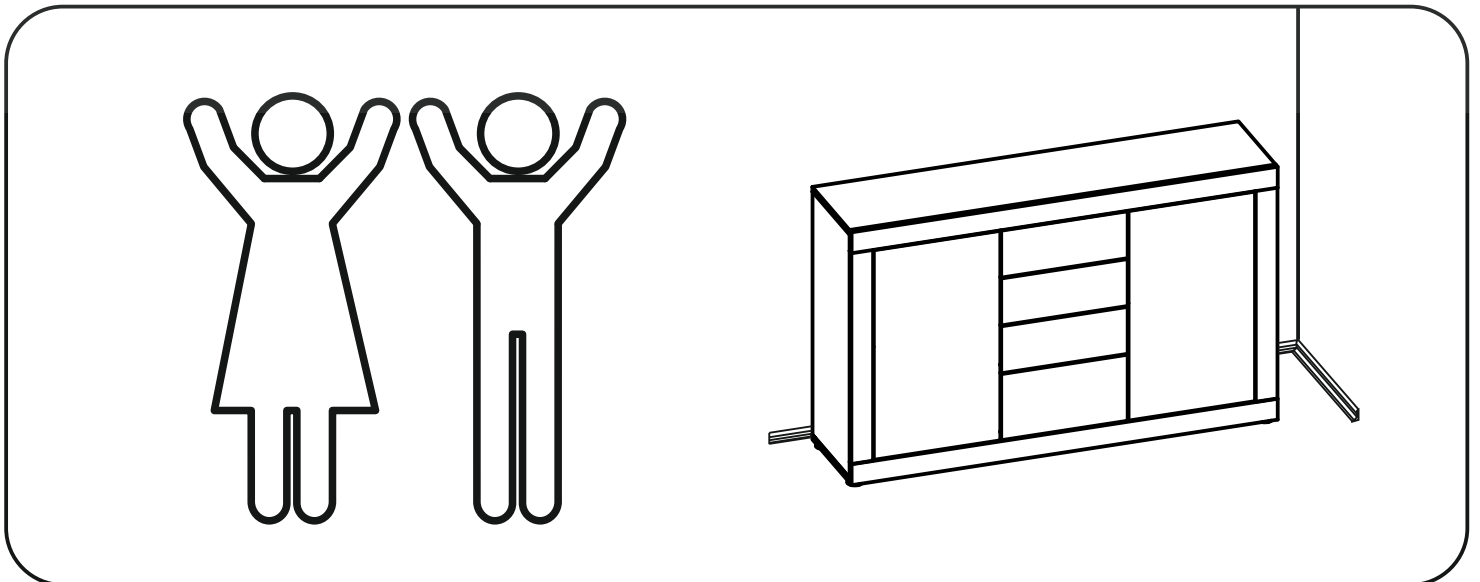
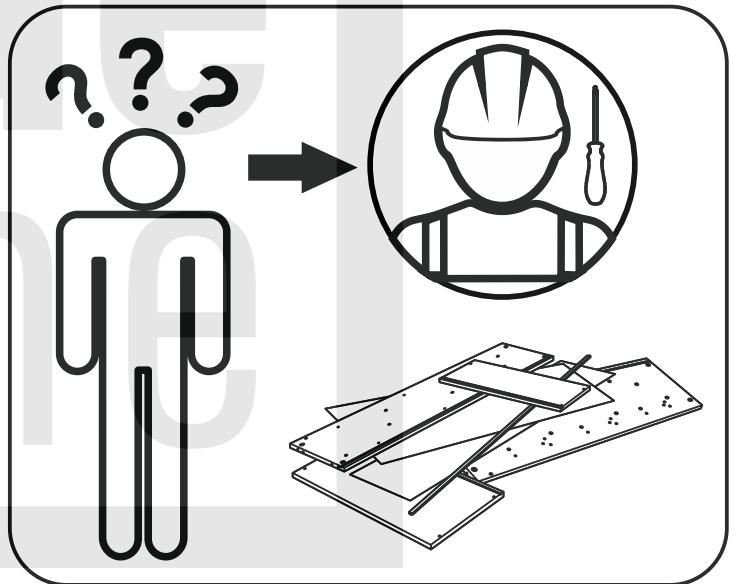
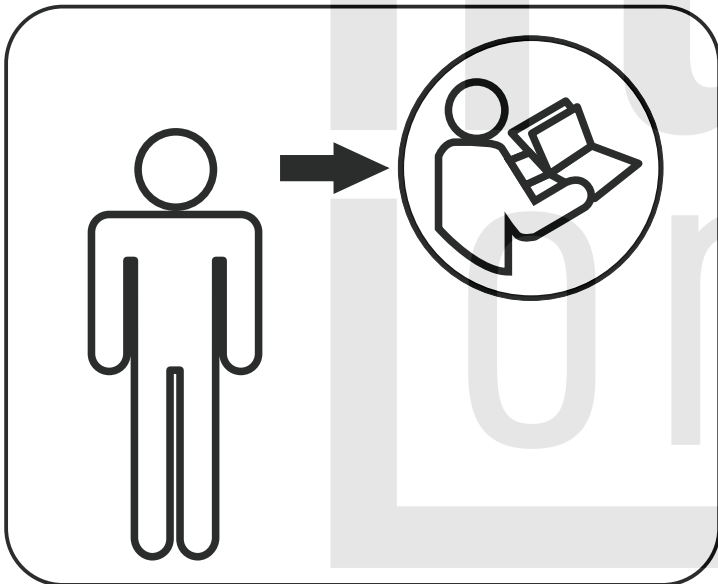
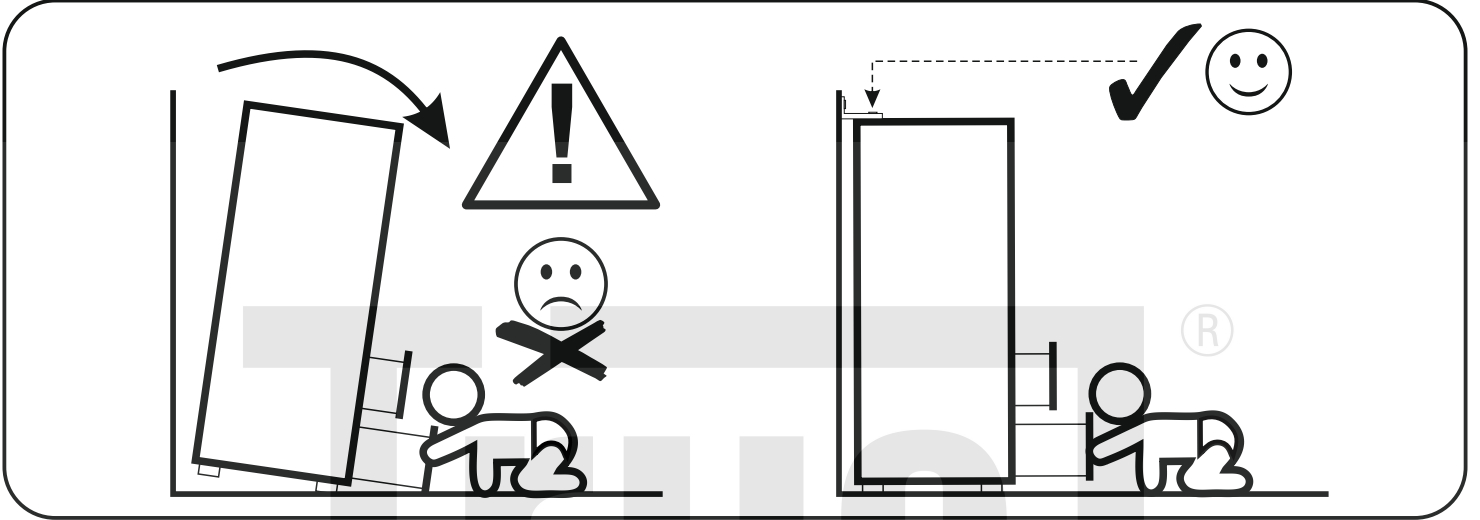
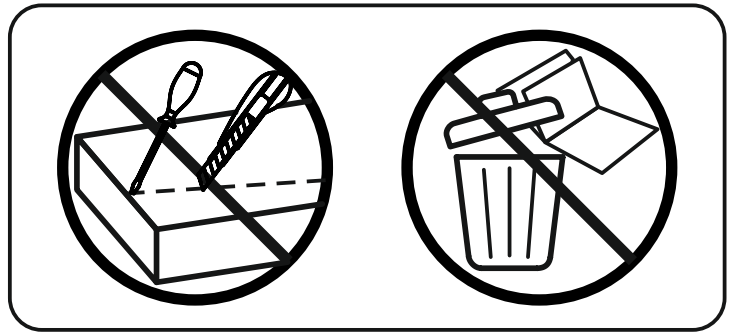
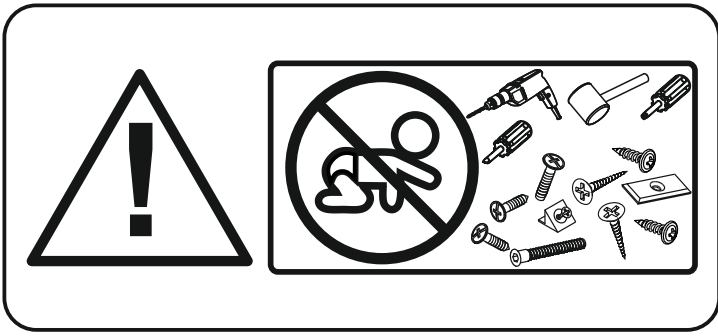
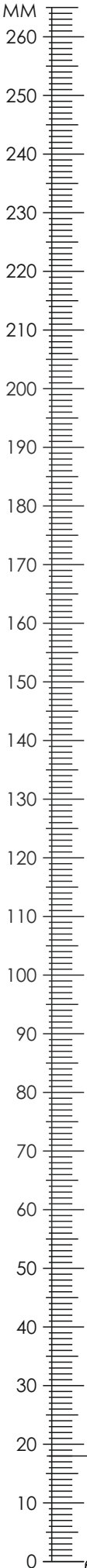

TYP 004-89-140-B



N5	3,5 x 16 mm	x24	Q8		x12
-----------	-------------	-----	-----------	---	-----

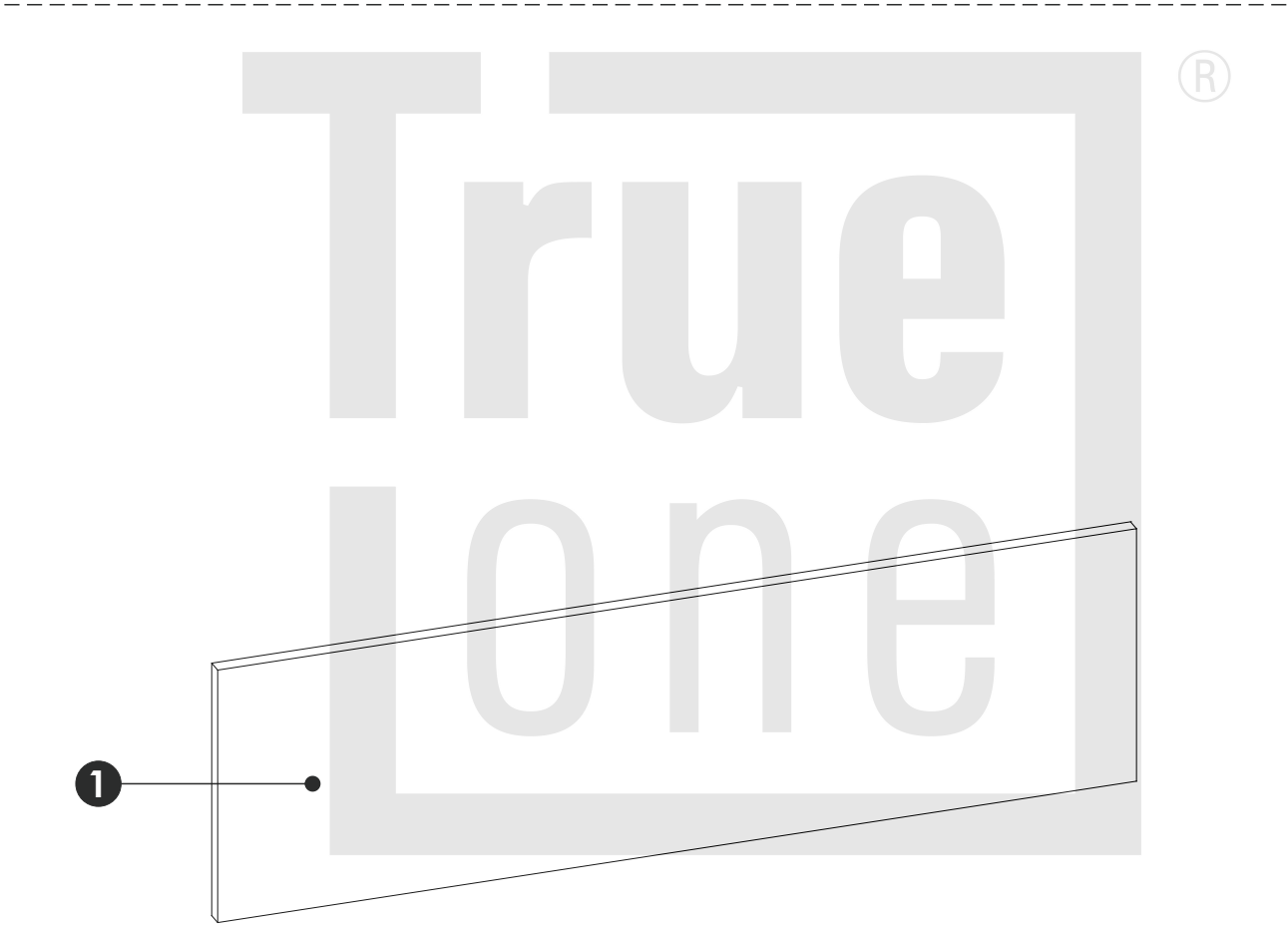

1	1404	400	25	x1	1/1
----------	------	-----	----	----	-----



1 ▶

x2

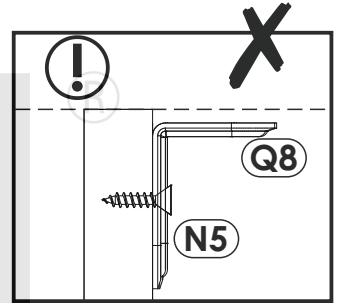
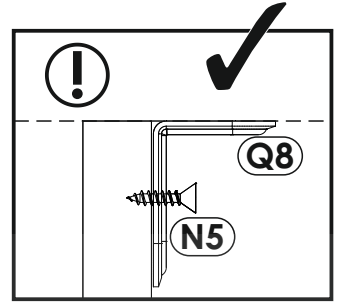
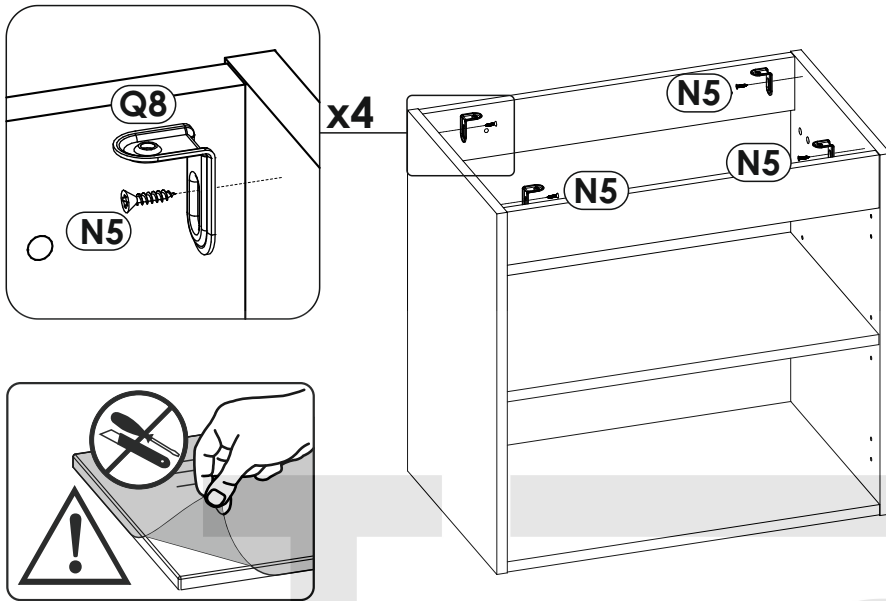

2 ▶

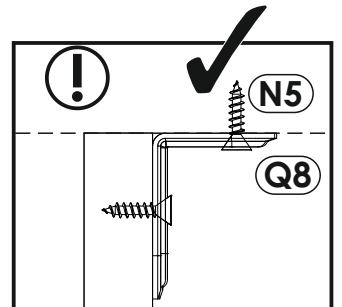
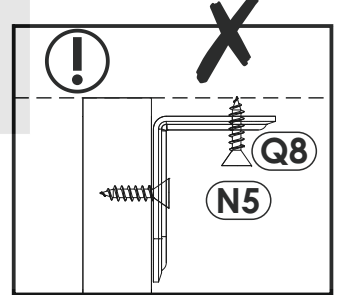
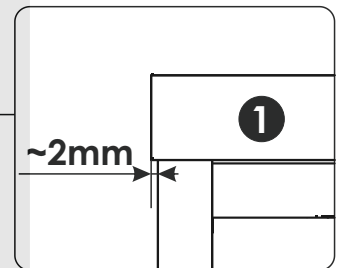
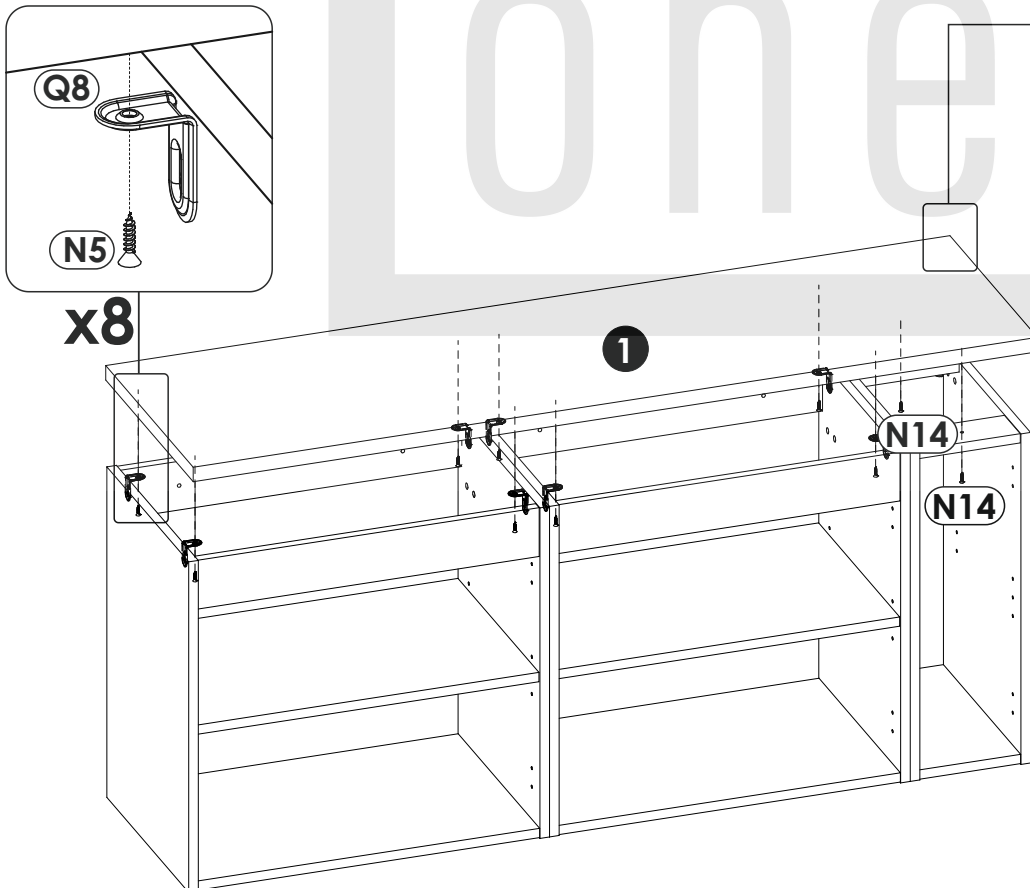

3 ▶

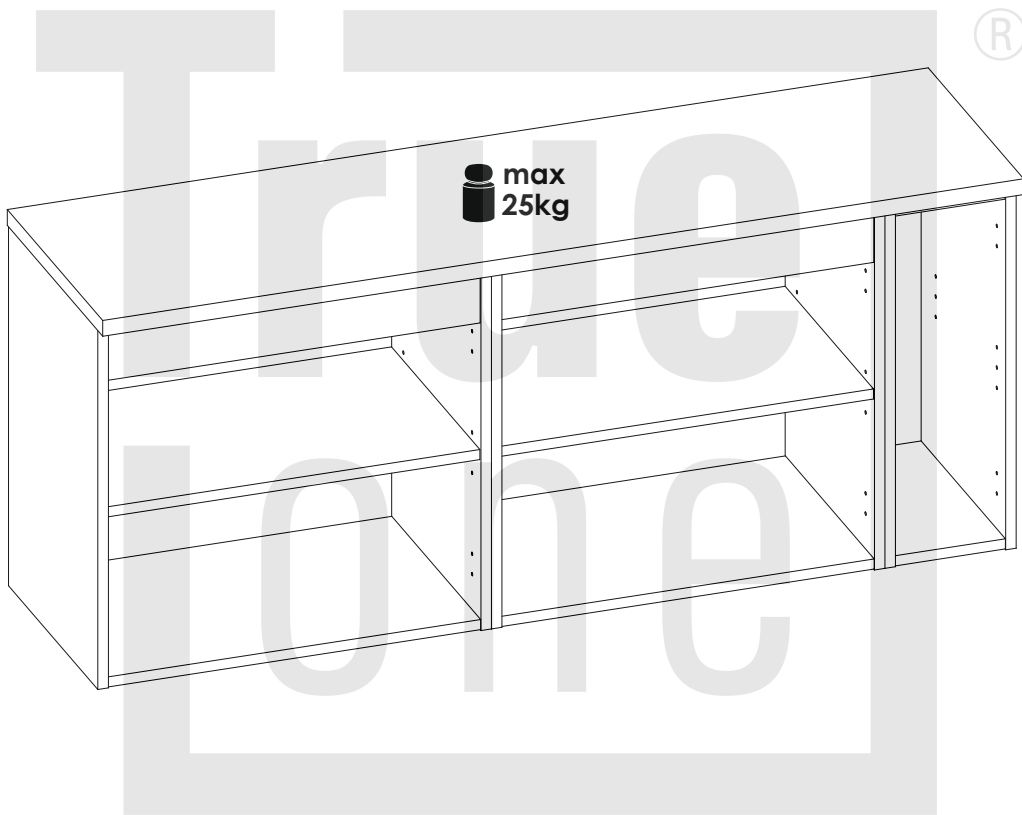

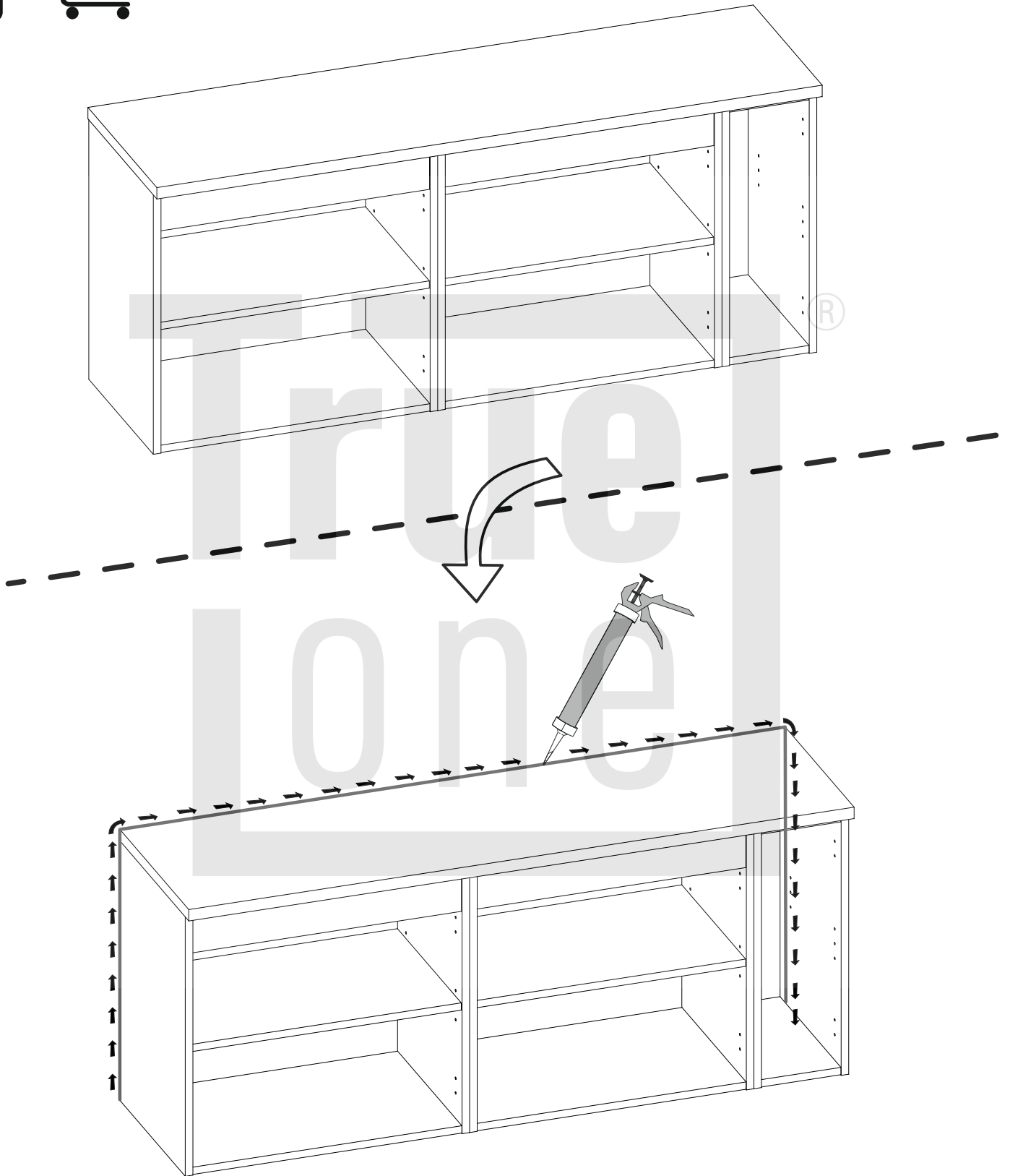
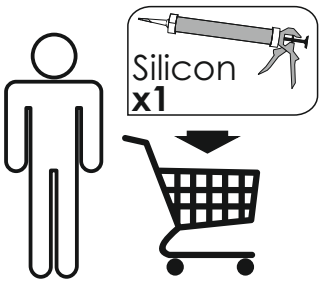

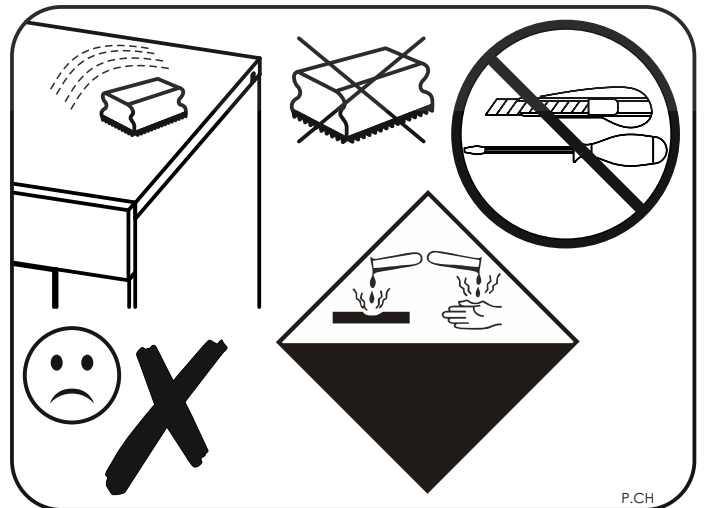
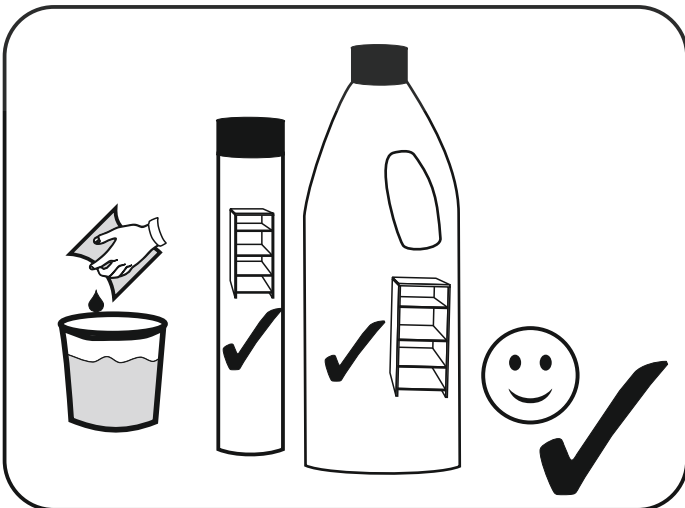
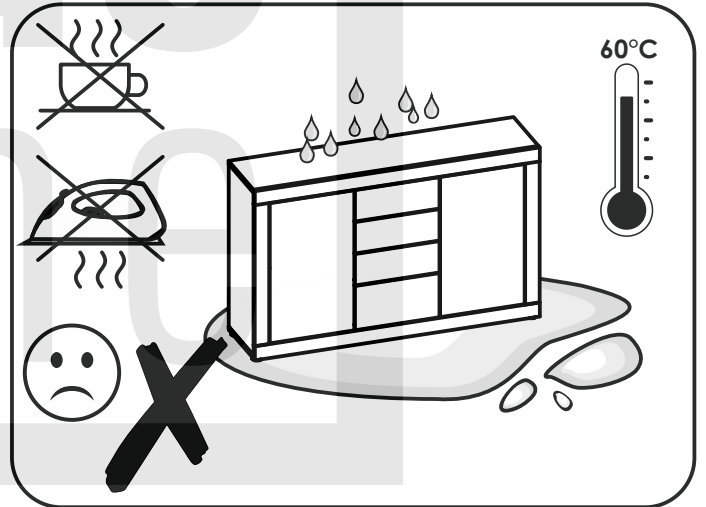
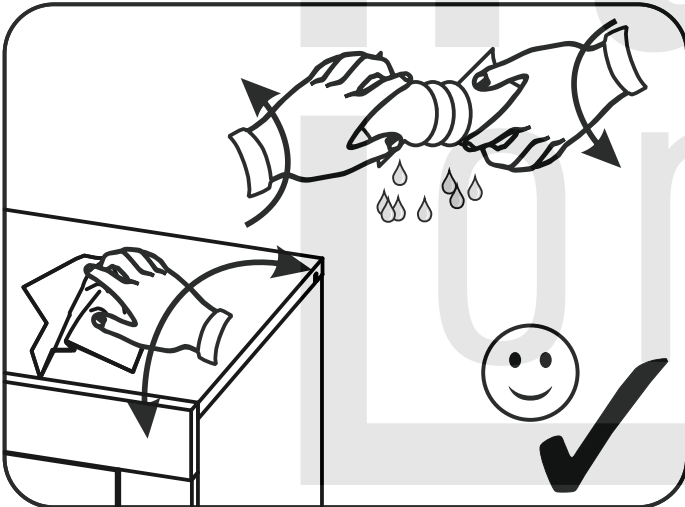
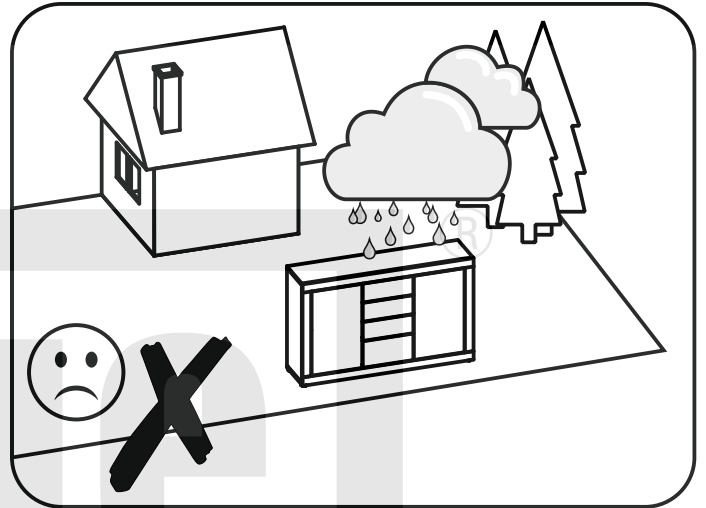
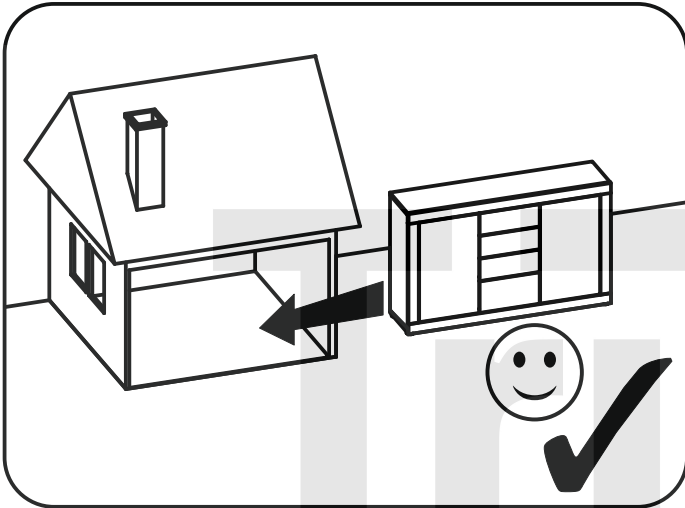
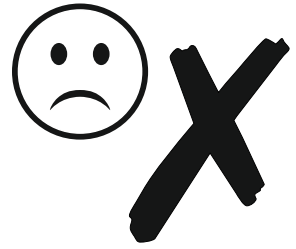

P.CH