

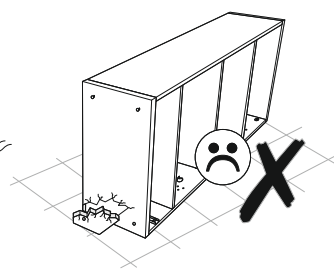

# TYP 004-89-160-A

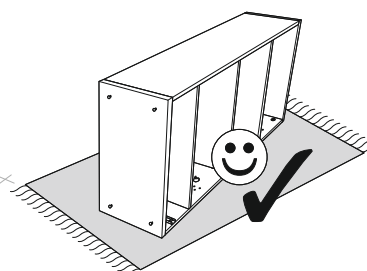

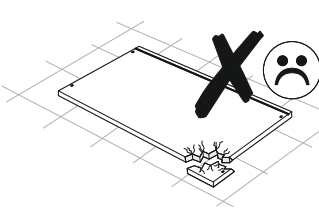
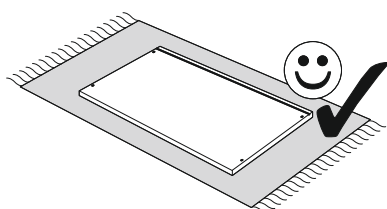
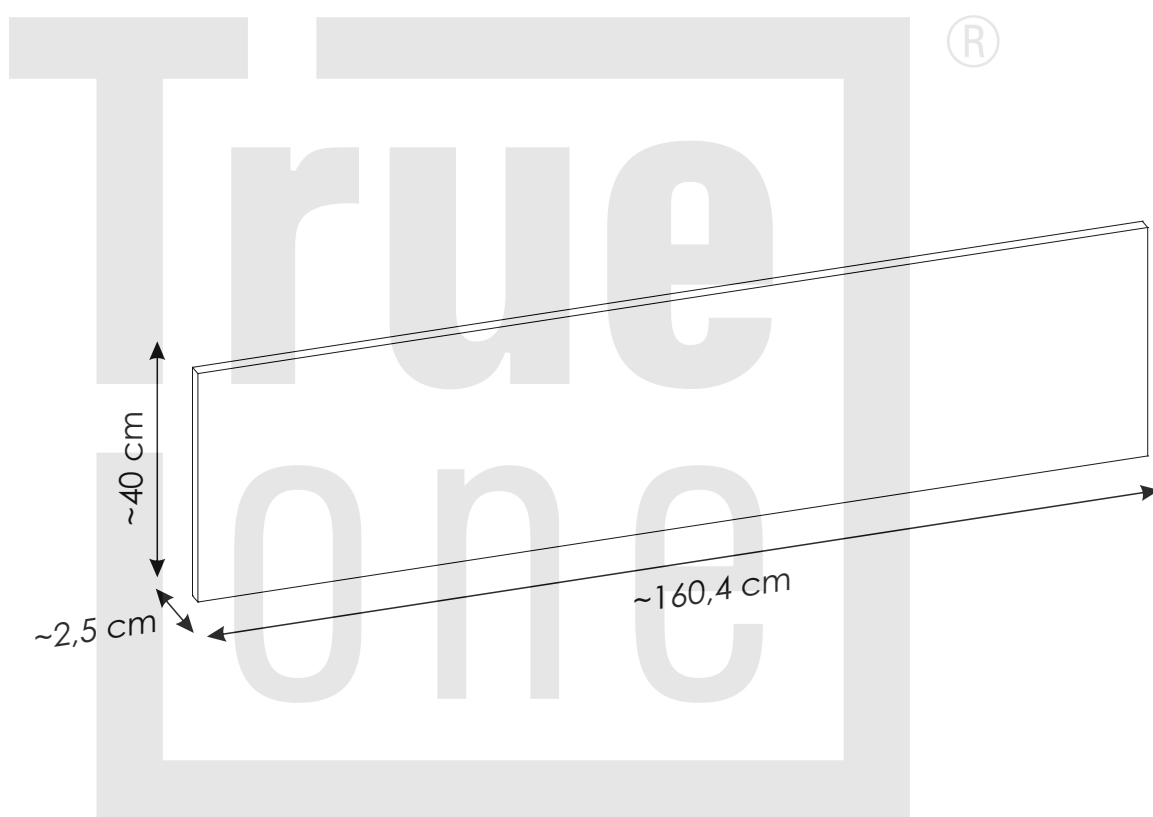
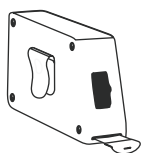
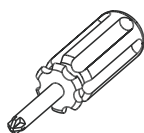
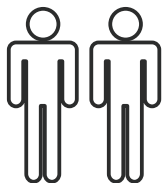
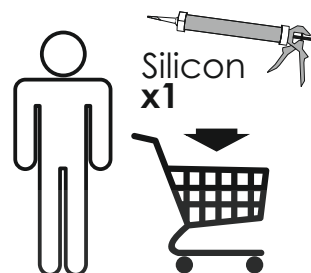
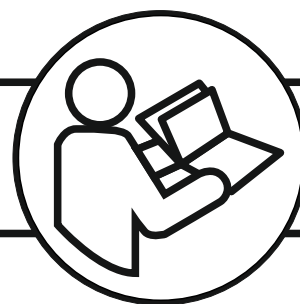
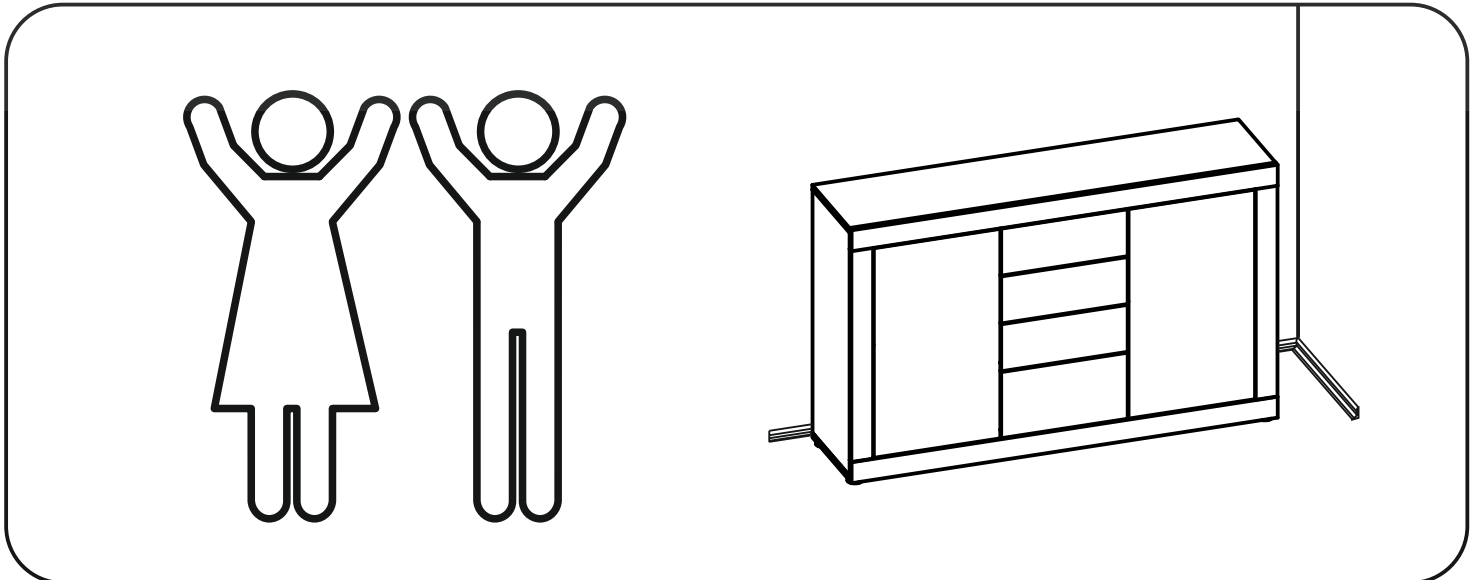
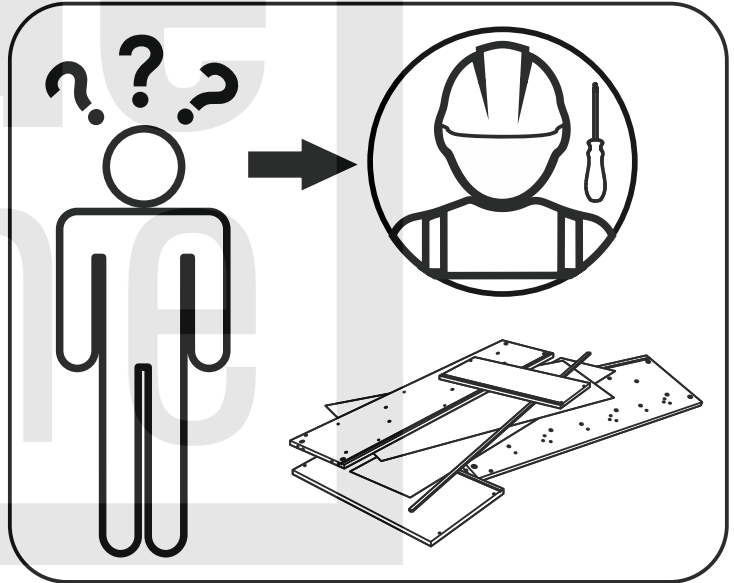
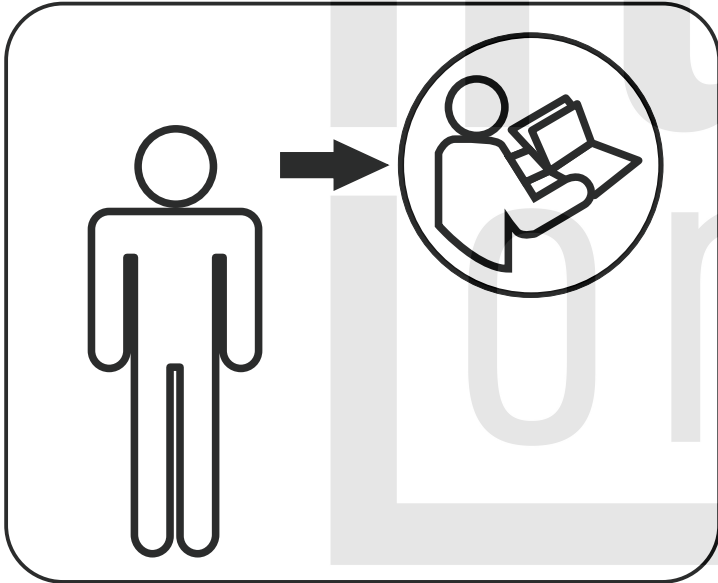
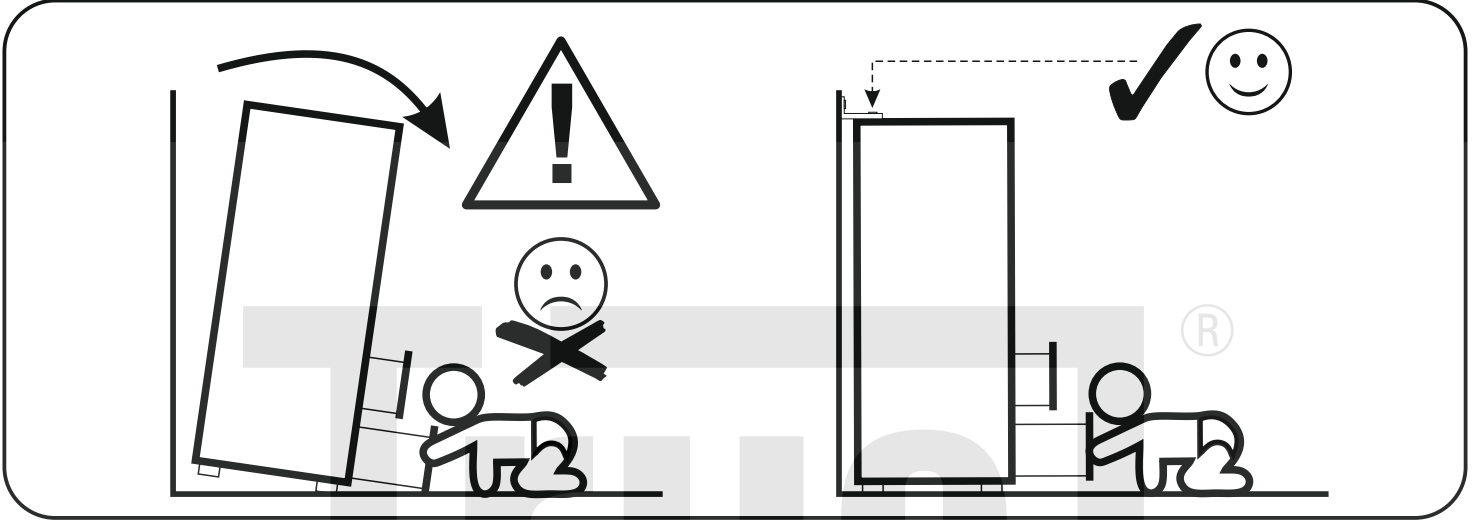
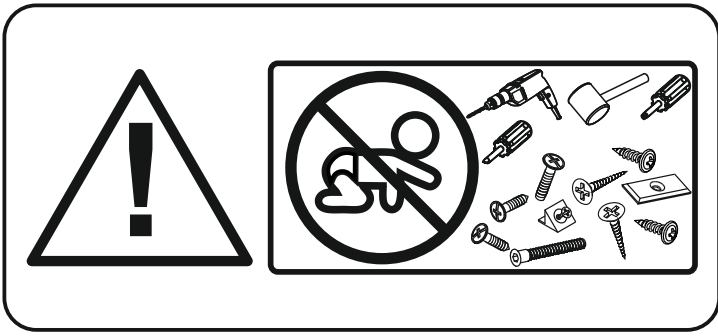
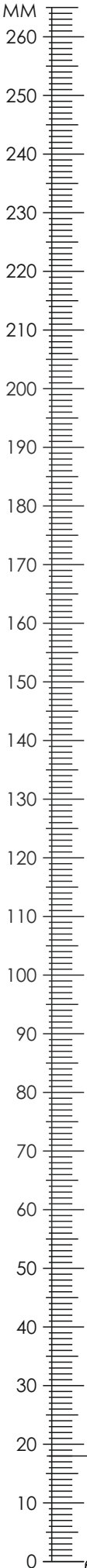

# TYP 004-89-160-A

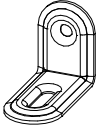

|   |             |     |   |     |
|---|-------------|-----|---|-----|
| <b>N5</b>   | 3,5 x 16 mm | x24 | <b>Q8</b>   | x12 |
|  |             |     |  |     |

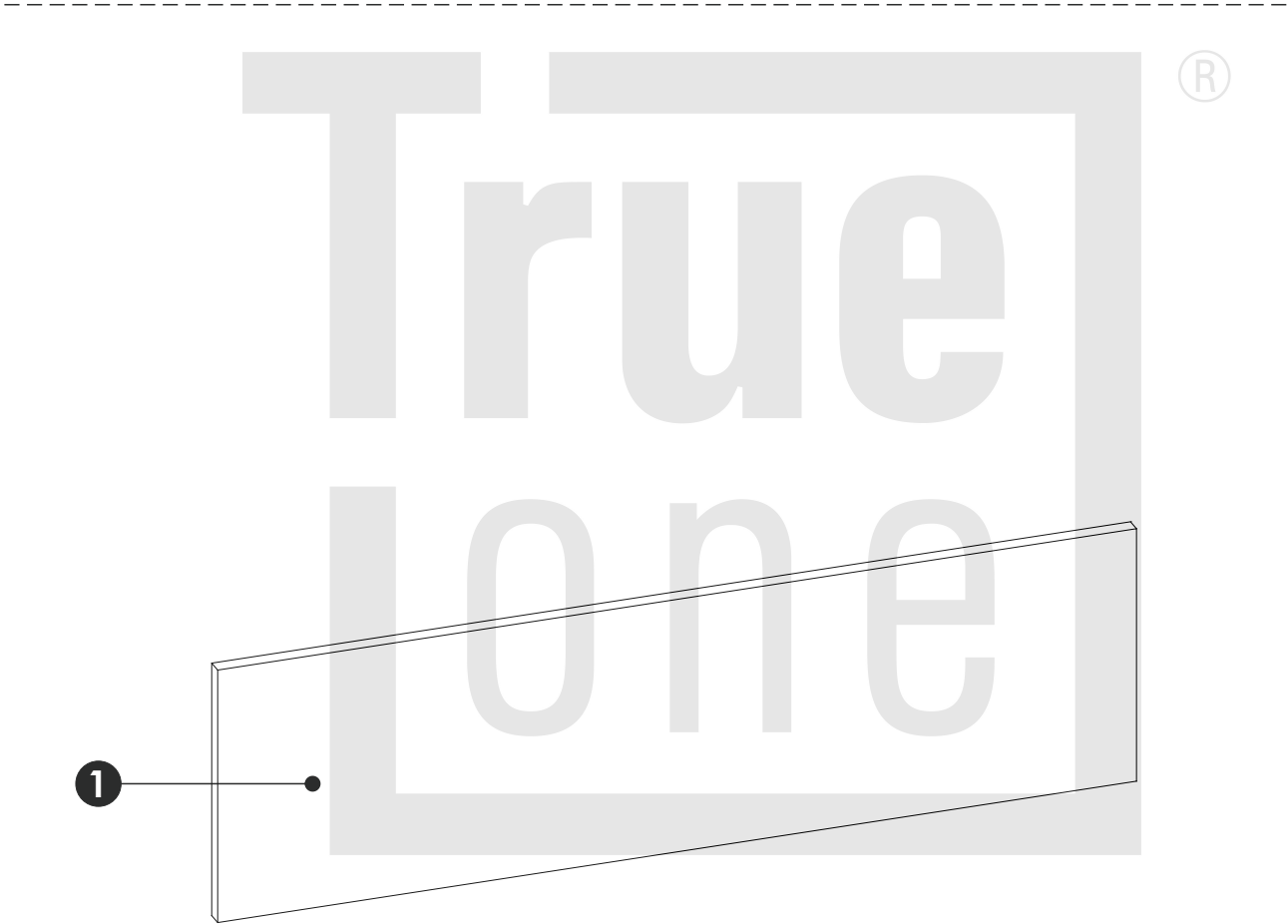

|          |      |     |    |    |     |
|----------|------|-----|----|----|-----|
| <b>1</b> | 1604 | 400 | 25 | x1 | 1/1 |
|----------|------|-----|----|----|-----|

1 ▶

x2

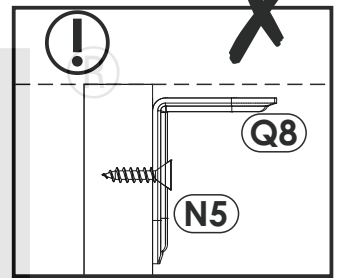
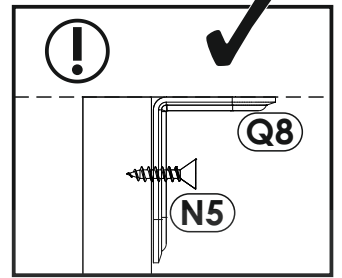
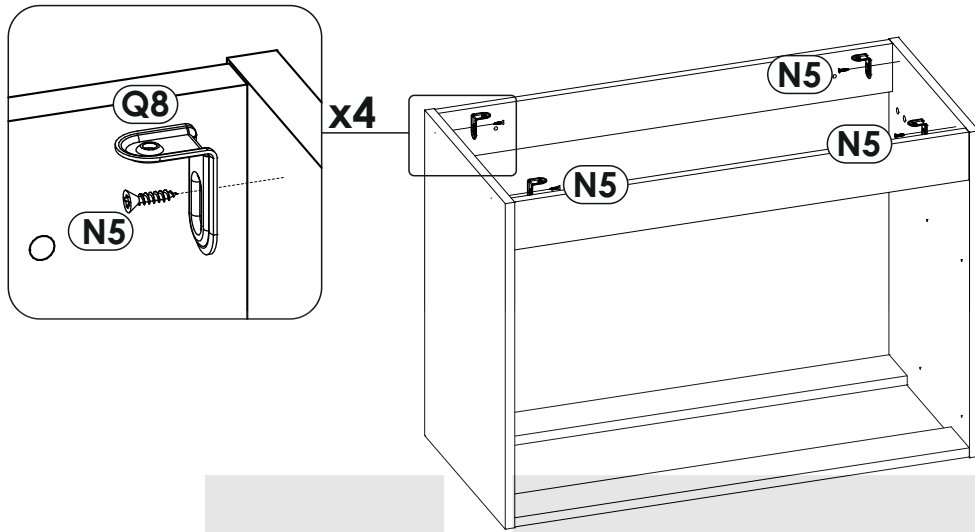

2 ▶

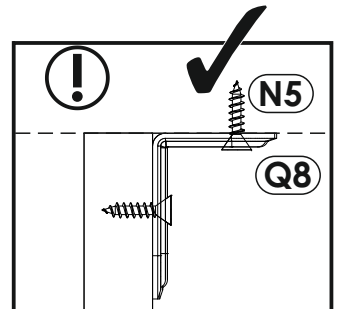
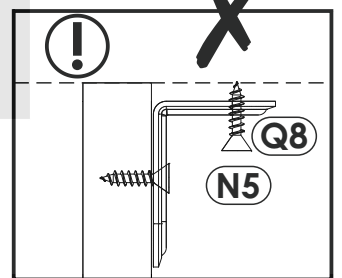
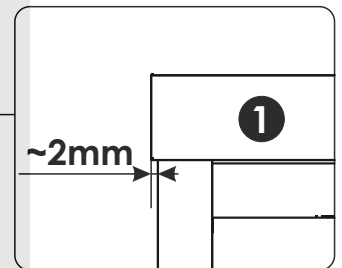
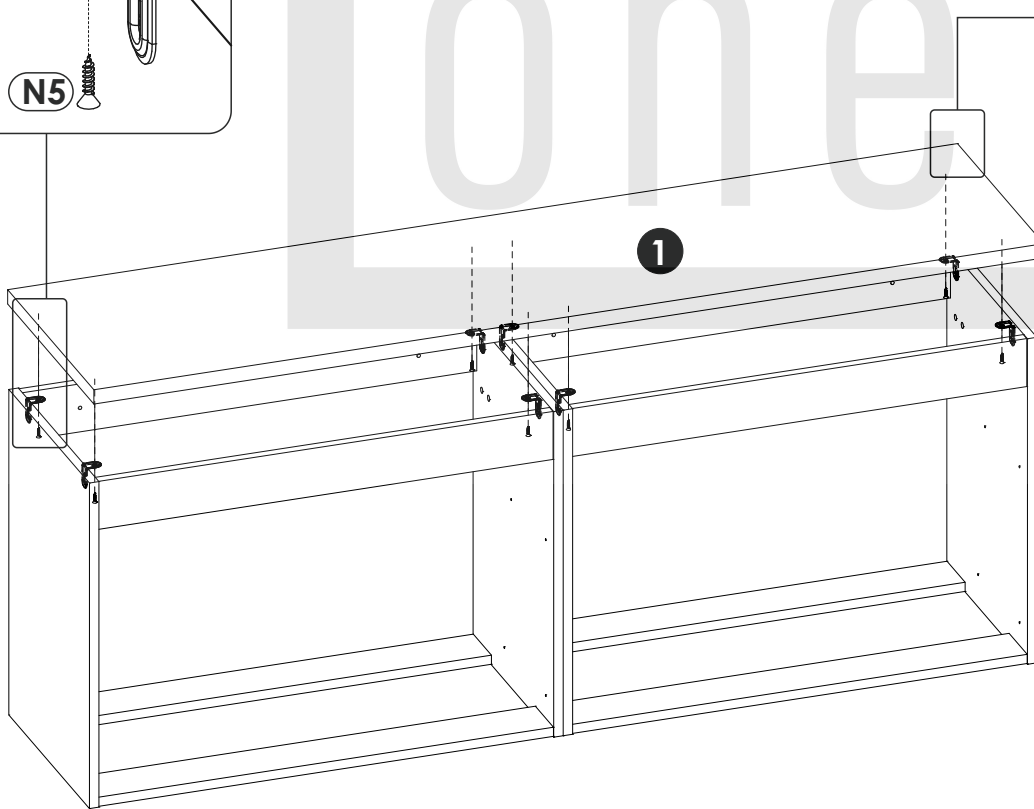
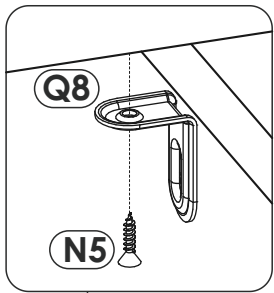

3 ▶

