

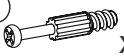













- (B1)**   $\phi$  8x28 x16
- (T1)**  x10
- (M1)**  x10
- (C2)**   $\phi$  20 x10
- (W1)**  x24
- (J23)**  x7
- (F1)**  x10
- (P2)**  3x16 x17

- (Z2c)**  x4
- (Z3c)**  x2
- (S9)**  4x16 x12

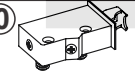
- (T30)**  x1
- (T31)**  x1
- (S12)**  4x30 x4
- (F33)**  x2
- (T17)**  $\phi$ 8x50  
 5x60 x4

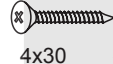
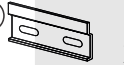
Nr	Ausmaß			St
2	672	180	16	1
3	672	180	16	1
4	669	296	20	3
5	647	158	16	1
6	647	158	16	1
7	276	155	16	4
8	282	155	16	2
9	866	159	16	1
10	900	200	22	1
11	669	296	2	1
12	669	290	2	1
13	669	290	2	1

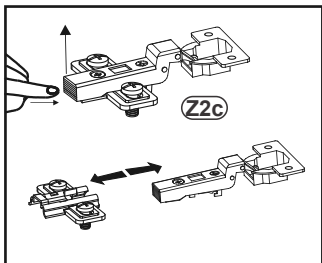
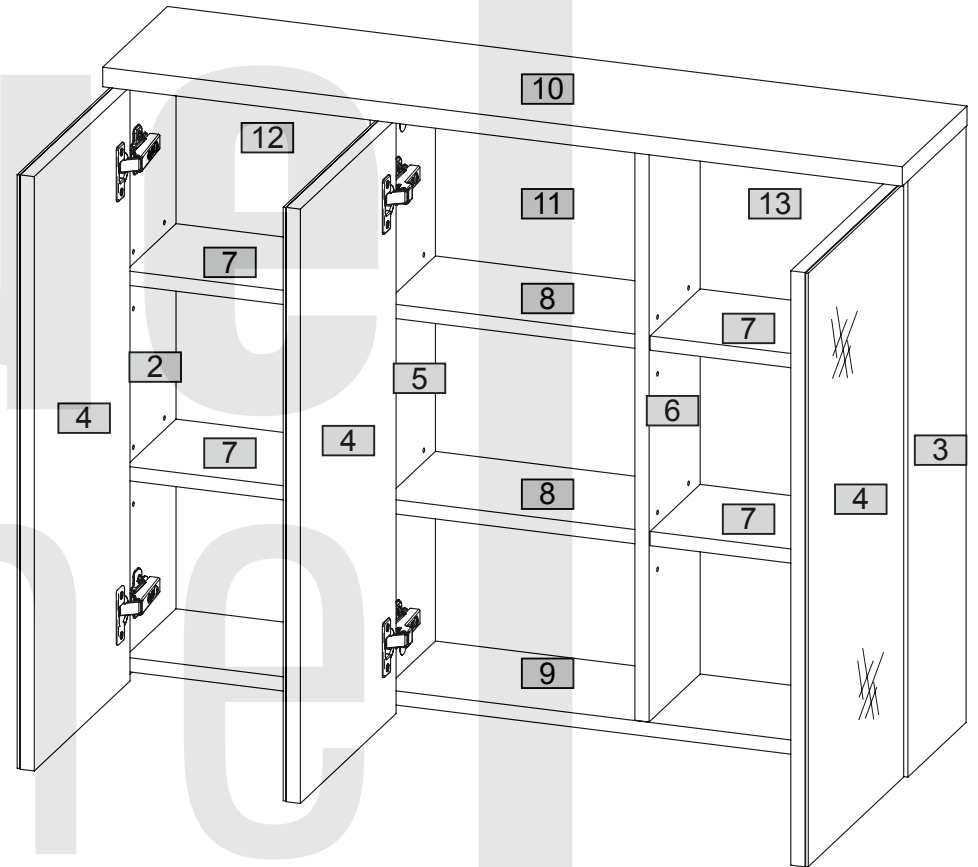

# 1

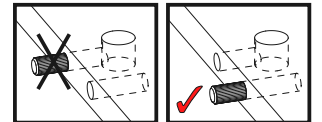
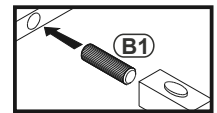
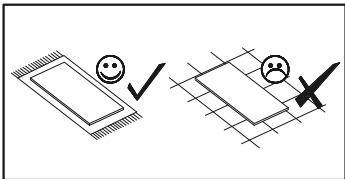
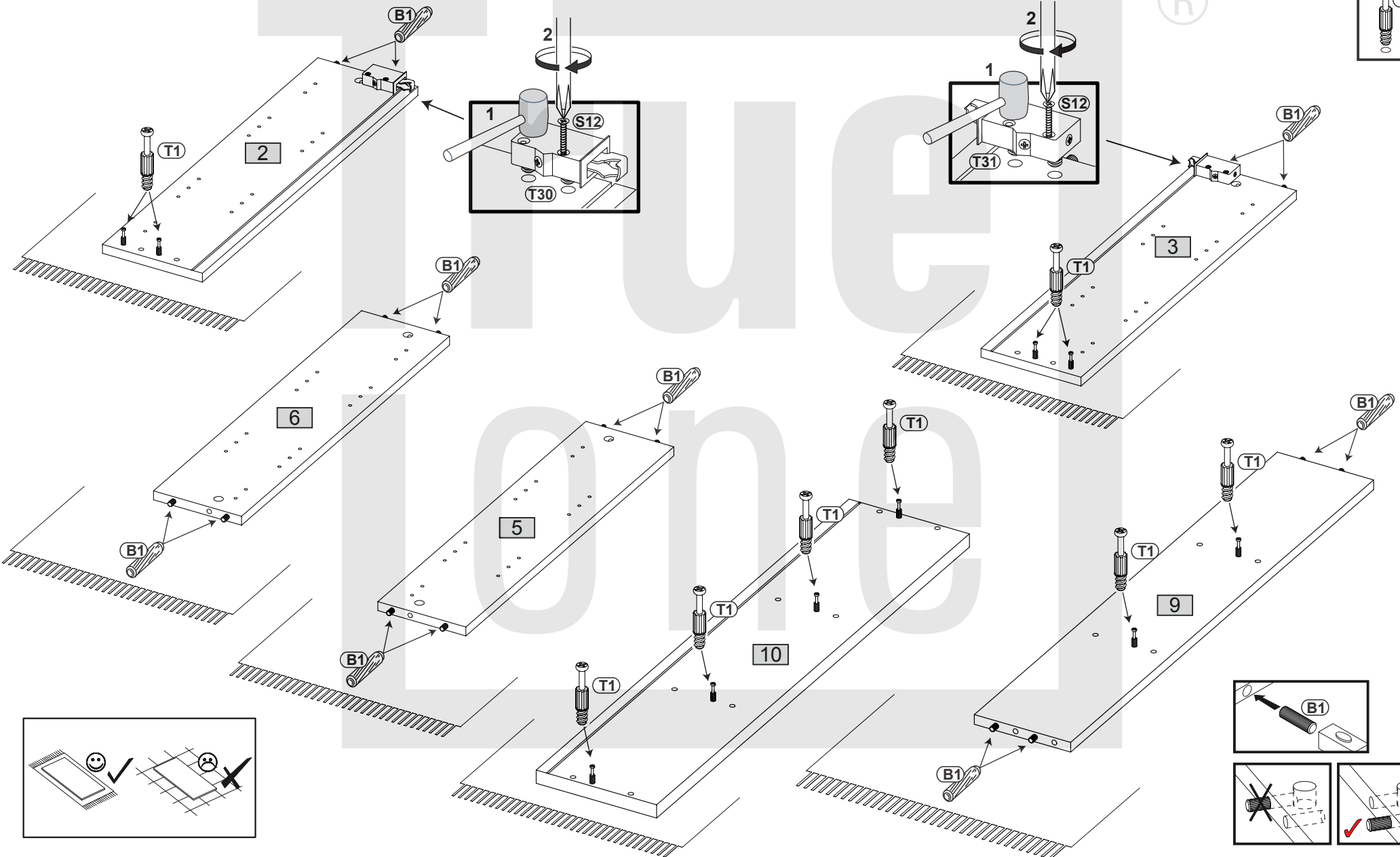
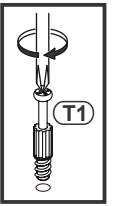
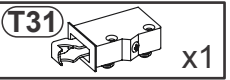
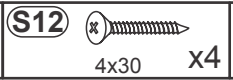
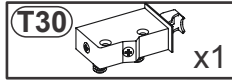
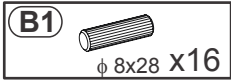
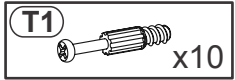

2

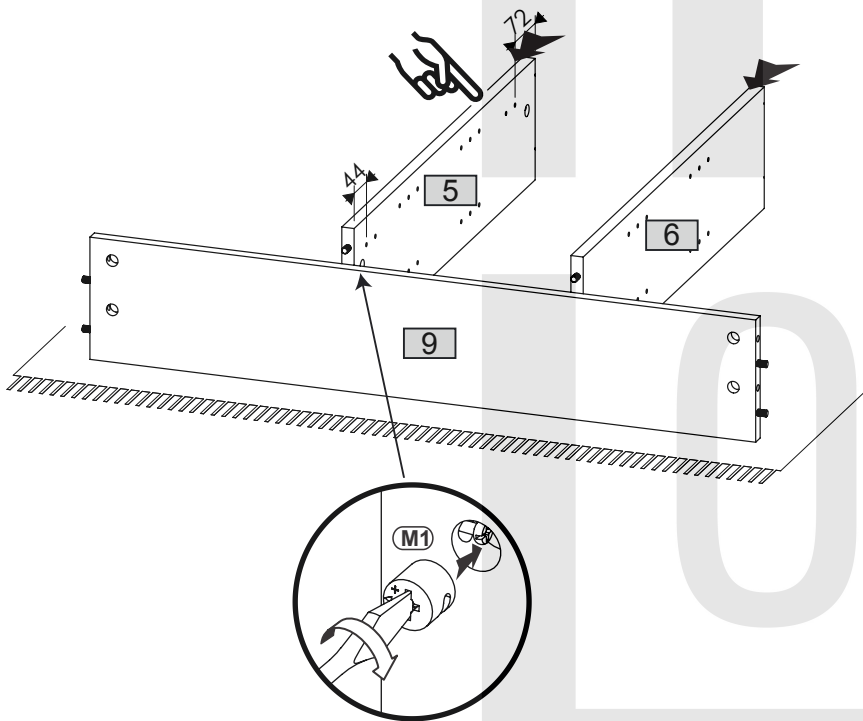

3

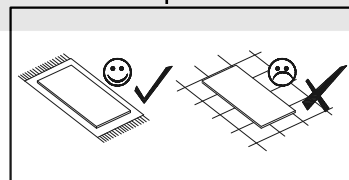
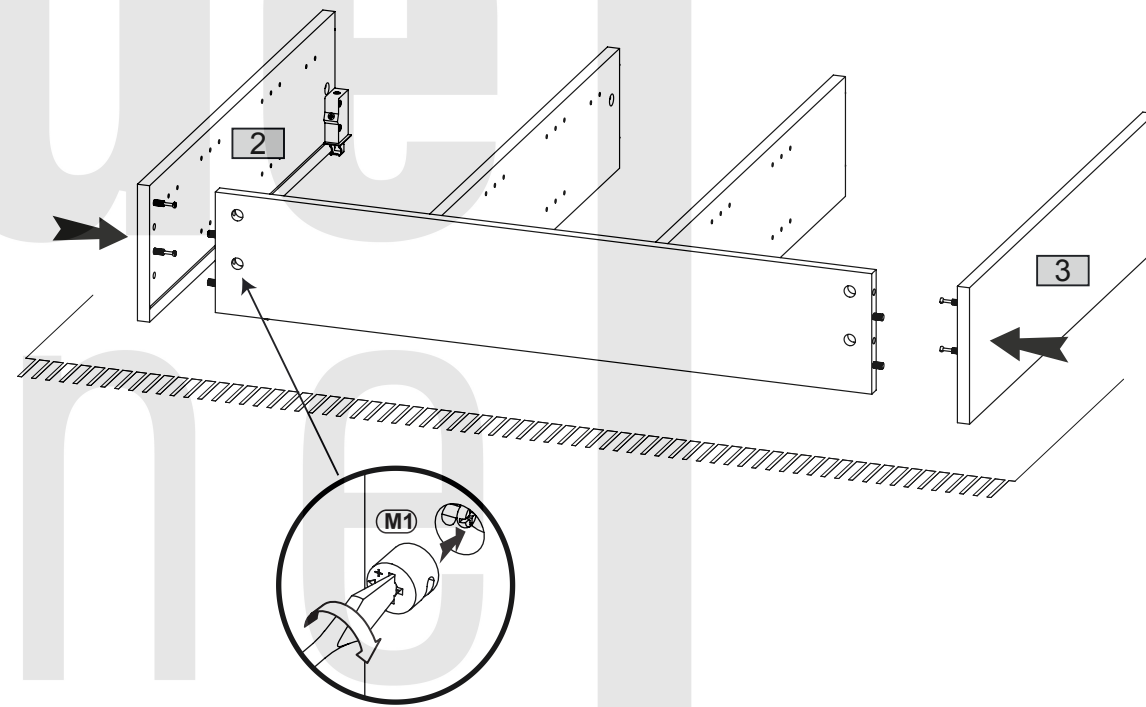

4

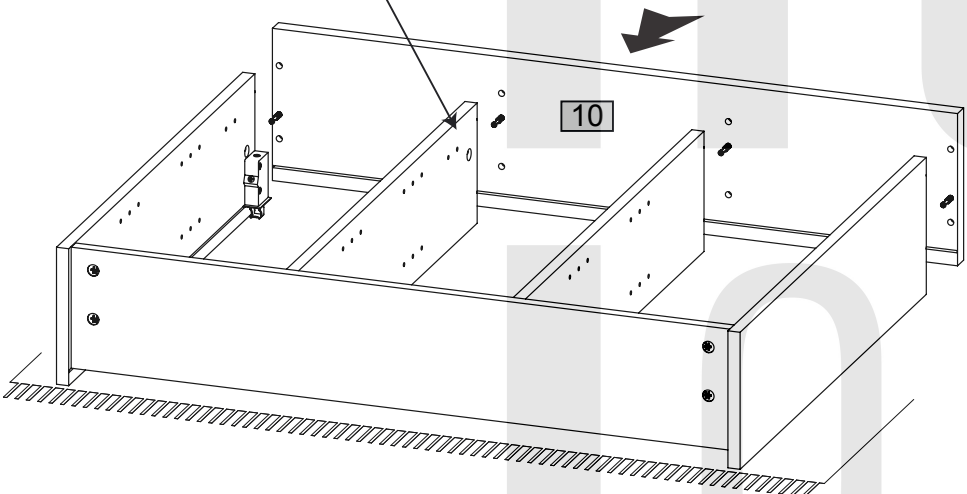
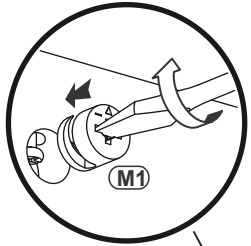

5

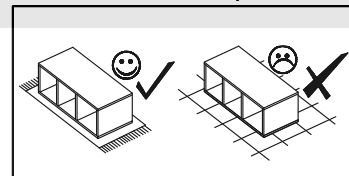
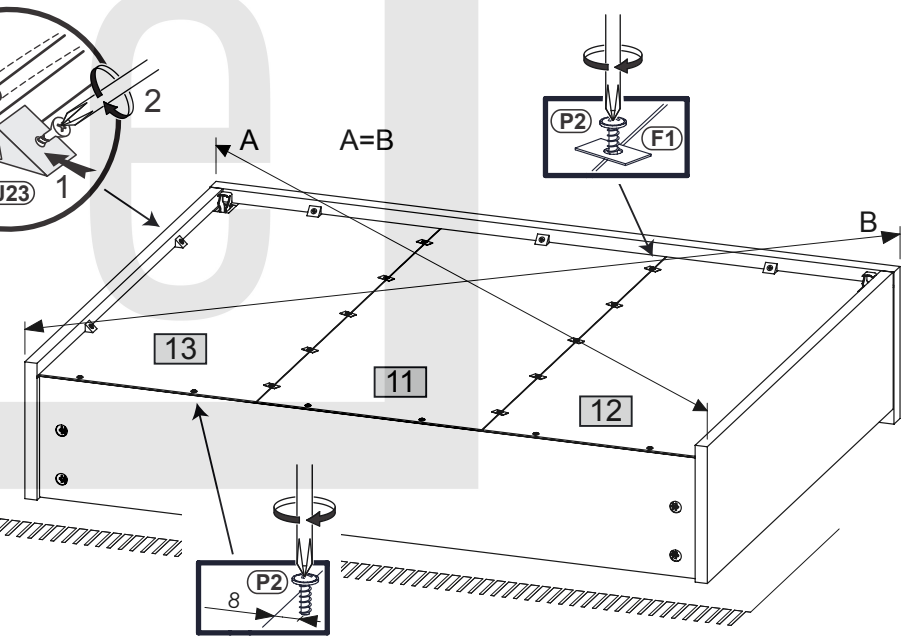
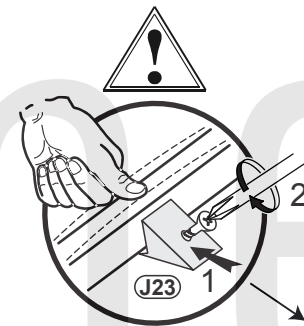
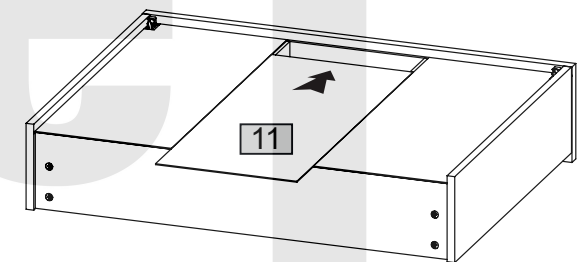
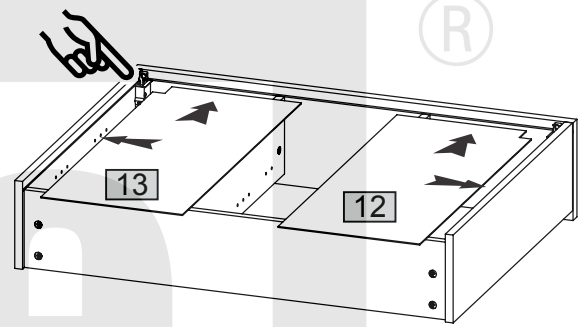
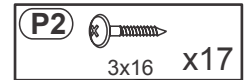
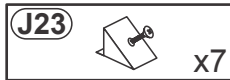

6

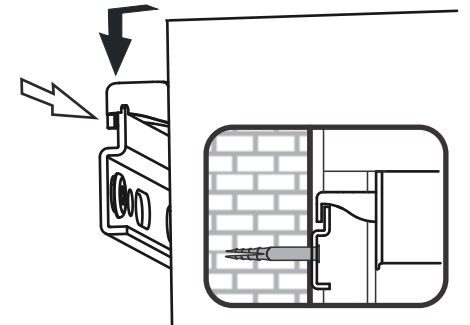
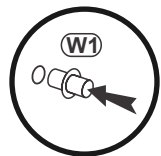
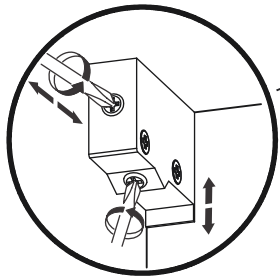
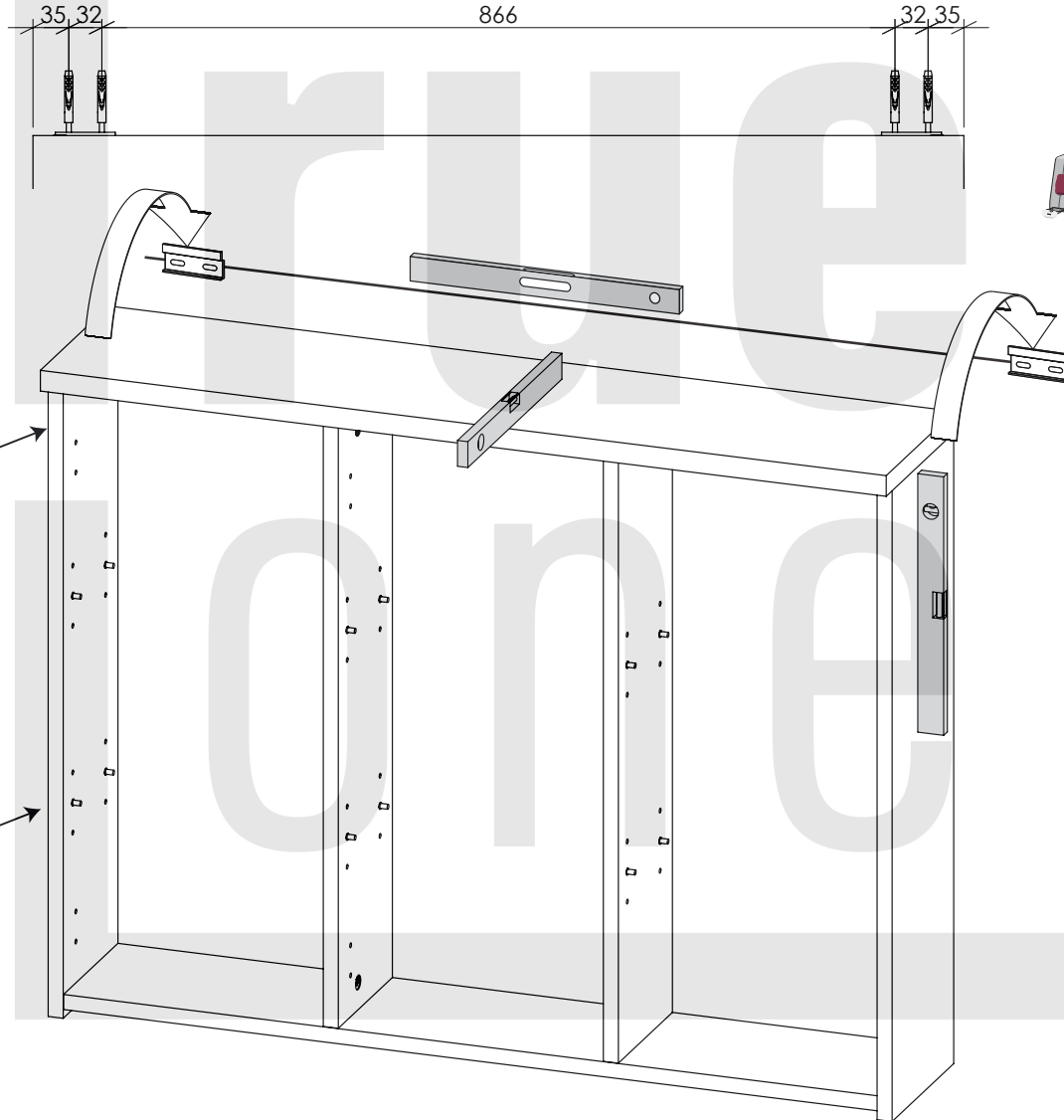
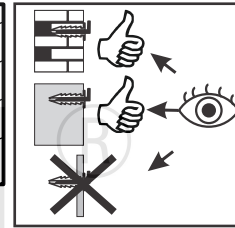
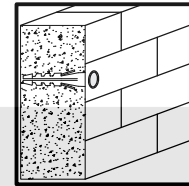
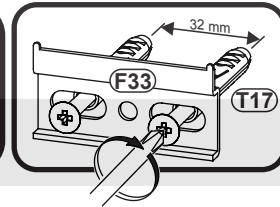
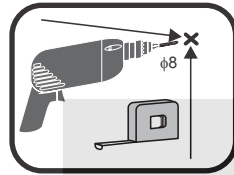
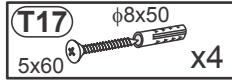
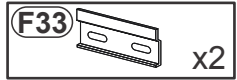

7

- Z2c x4
- S9 4x16 x12
- Z3c x2

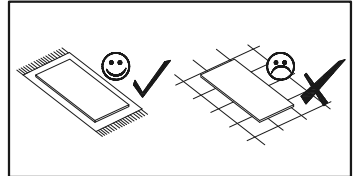
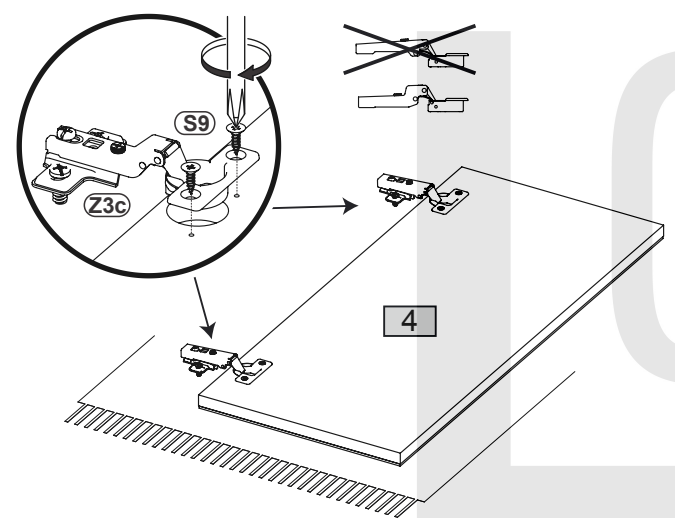
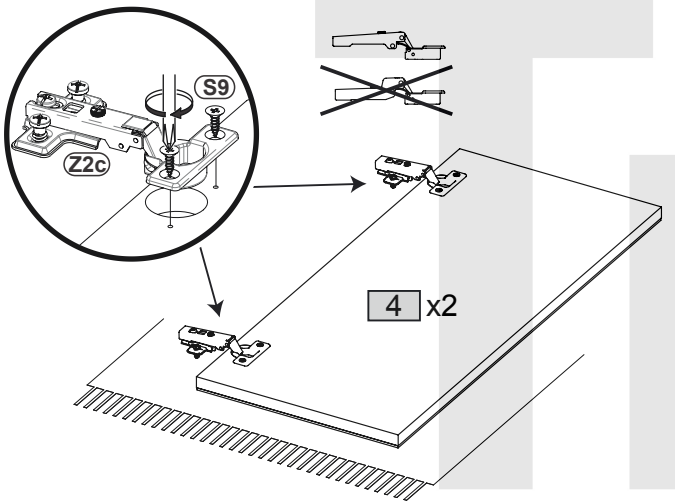

8

- C2  $\phi$  20 x10

