

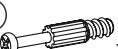









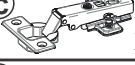
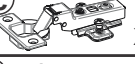

- B1**   $\phi 8 \times 28 \times 16$
- T1**  x10
- M1**  x10
- C2**   $\phi 20$  x10
- W1**  x24
- J23**  x7
- F1**  x10
- P2**   $3 \times 16$  x19

- Z2c**  x4
- Z3c**  x2
- S9**   $4 \times 16$  x12

- T30**  x1
- T31**  x1
- S12**   $4 \times 30$  x4
- F33**  x2
- T17**   $\phi 8 \times 50$   $5 \times 60$  x4

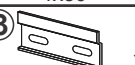
Nr	Ausmaß		St	
2	672	180	16	1
3	672	180	16	1
4	669	396	20	3
5	647	158	16	1
6	647	158	16	1
7	376	155	16	4
8	382	155	16	2
9	1166	159	16	1
10	1200	200	22	1
11	669	396	2	1
12	669	390	2	1
13	669	390	2	1

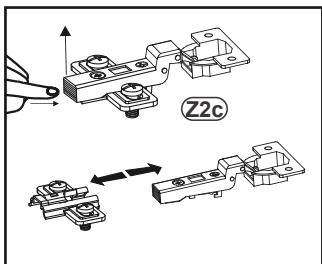
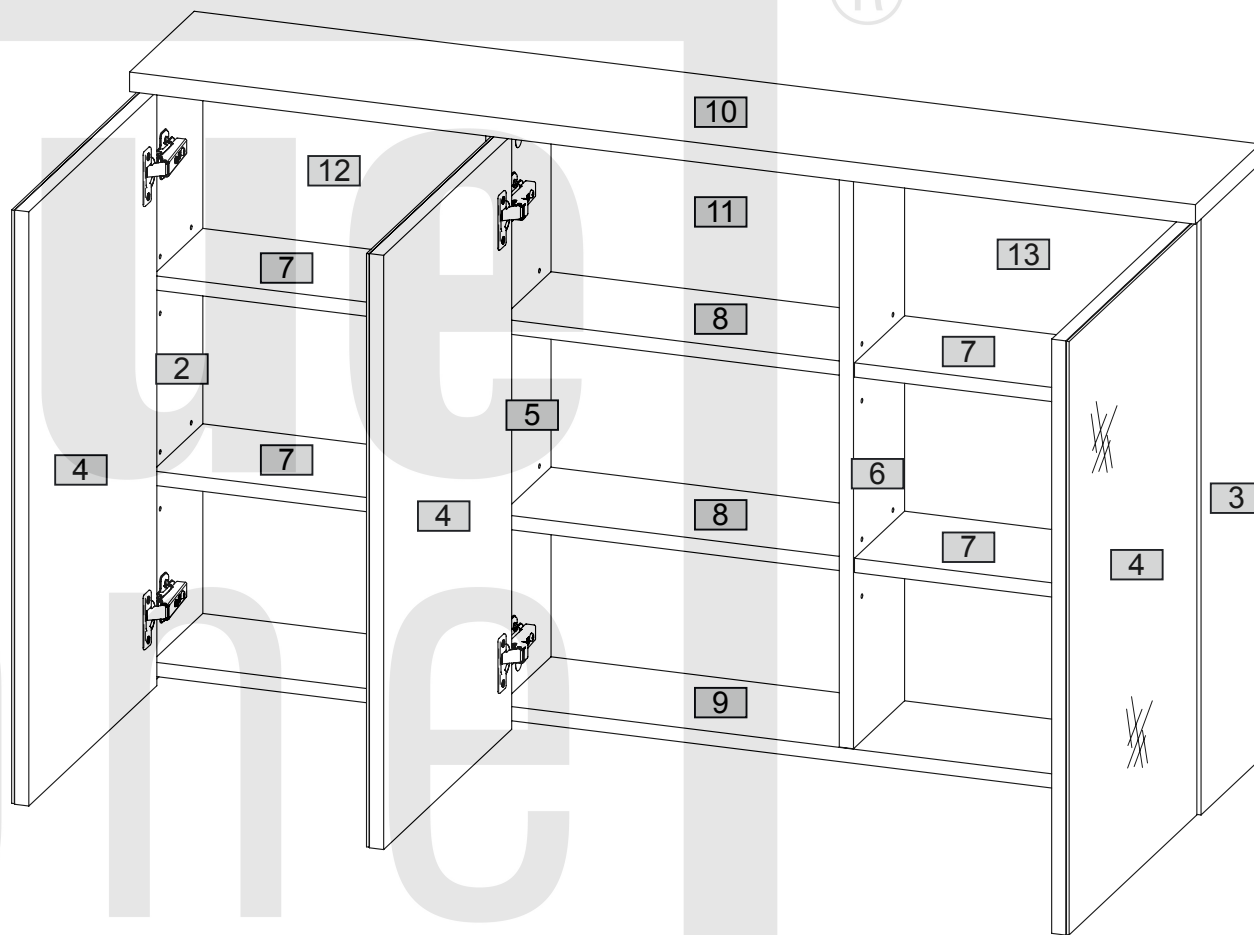

# 1

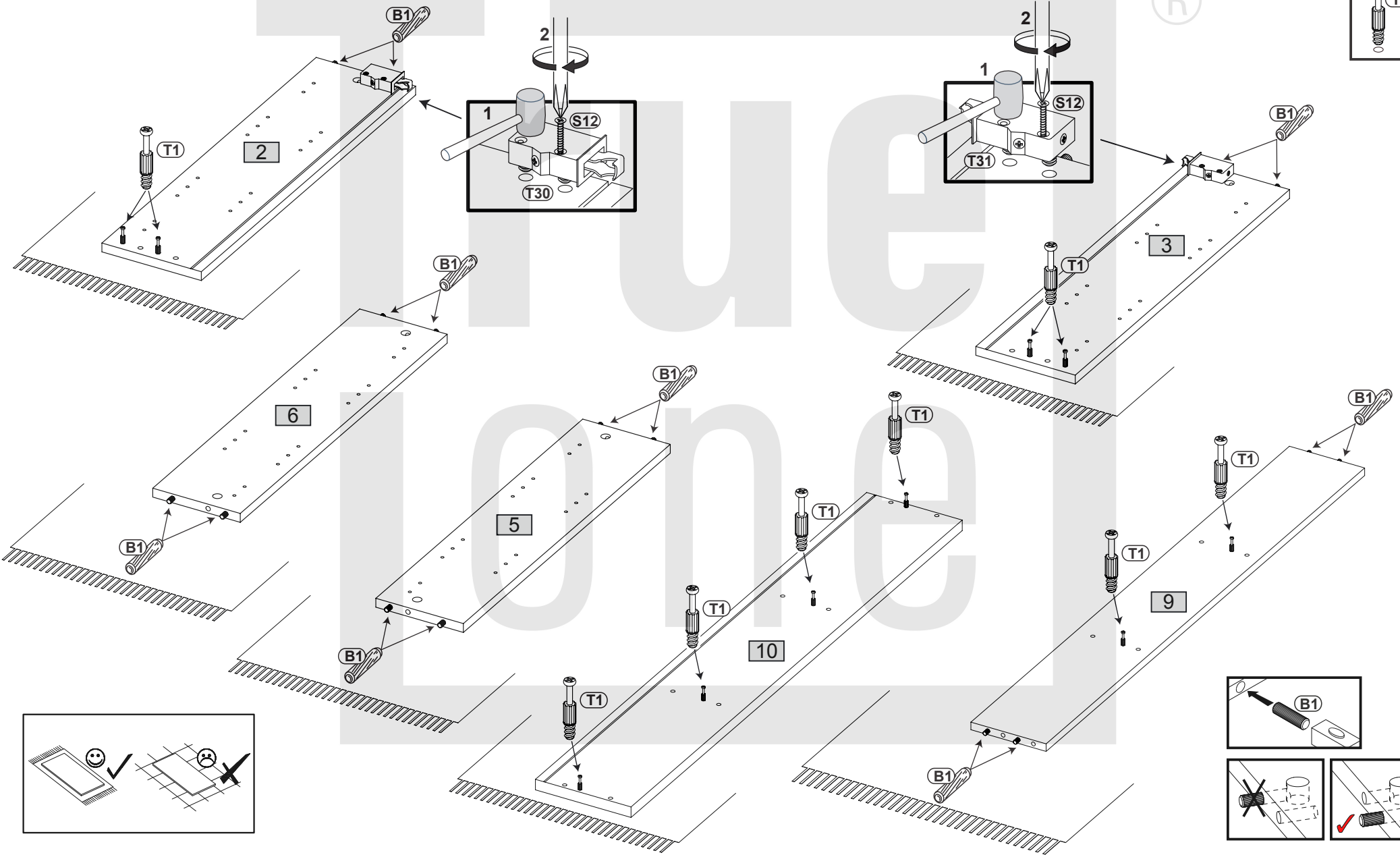
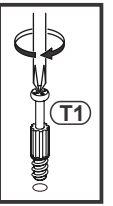
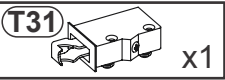
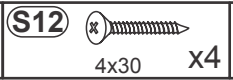
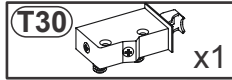
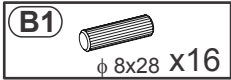
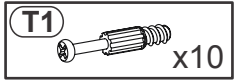

2

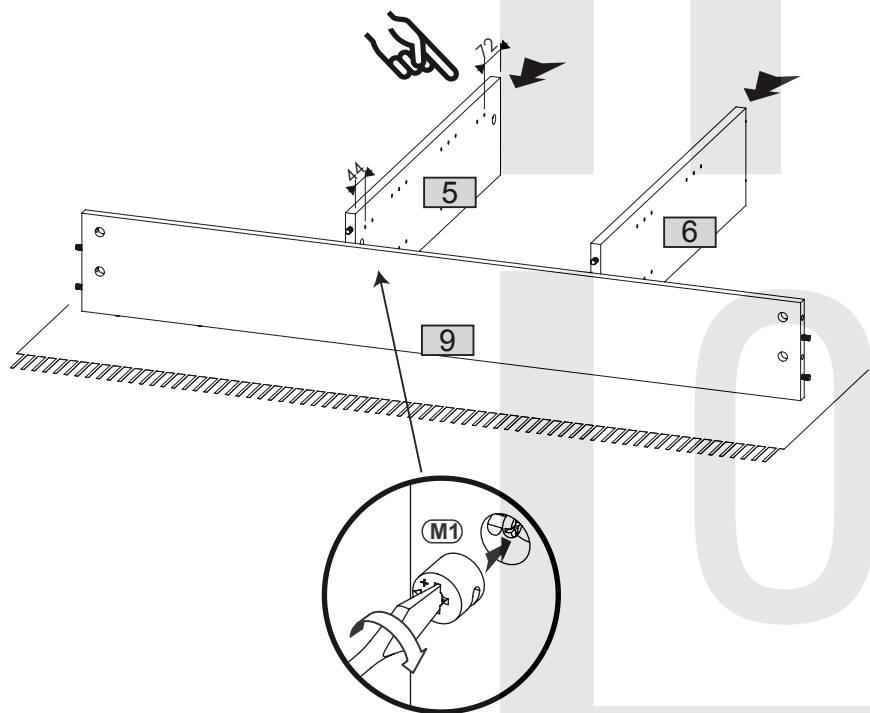

3

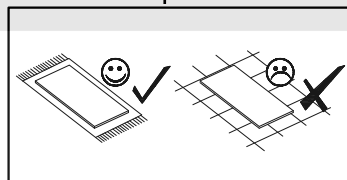
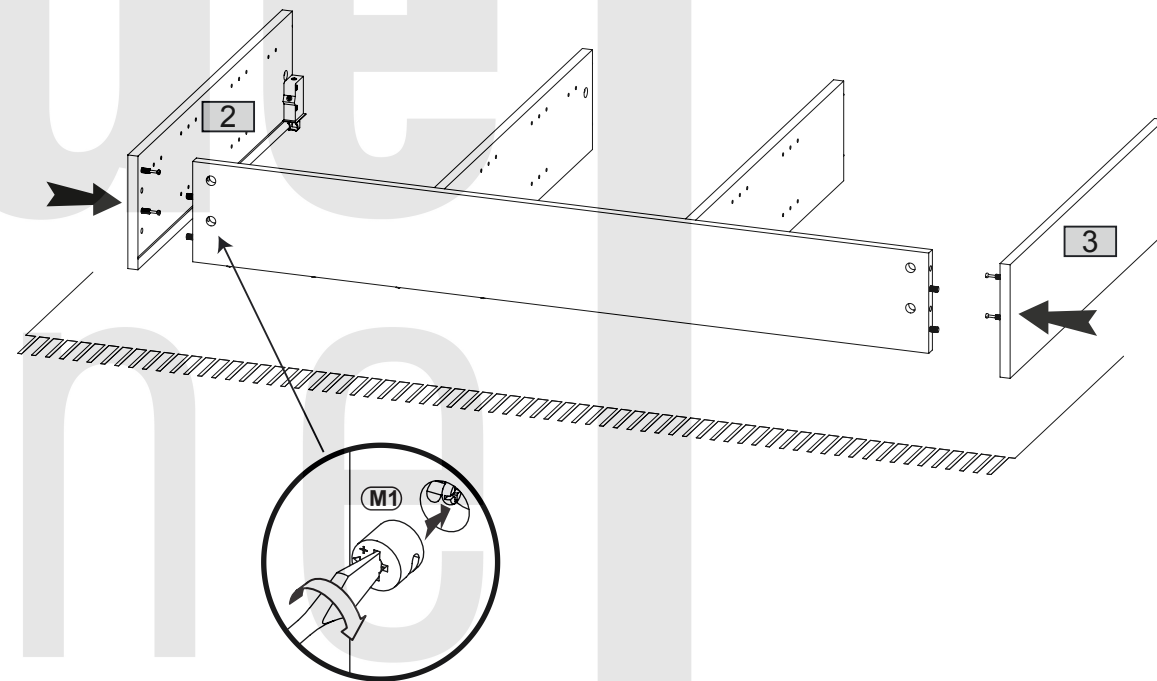

4

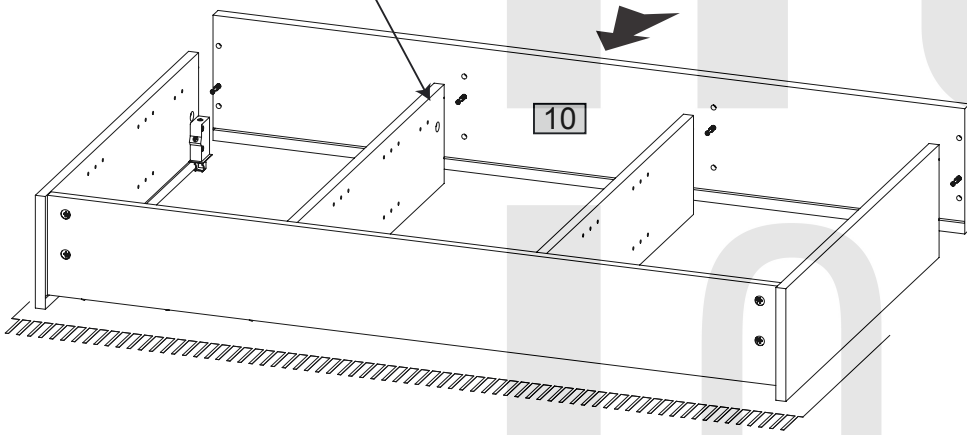
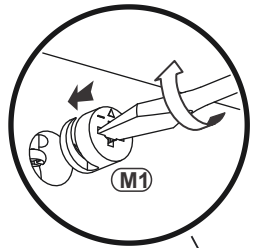

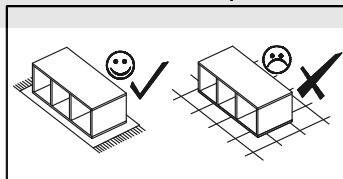
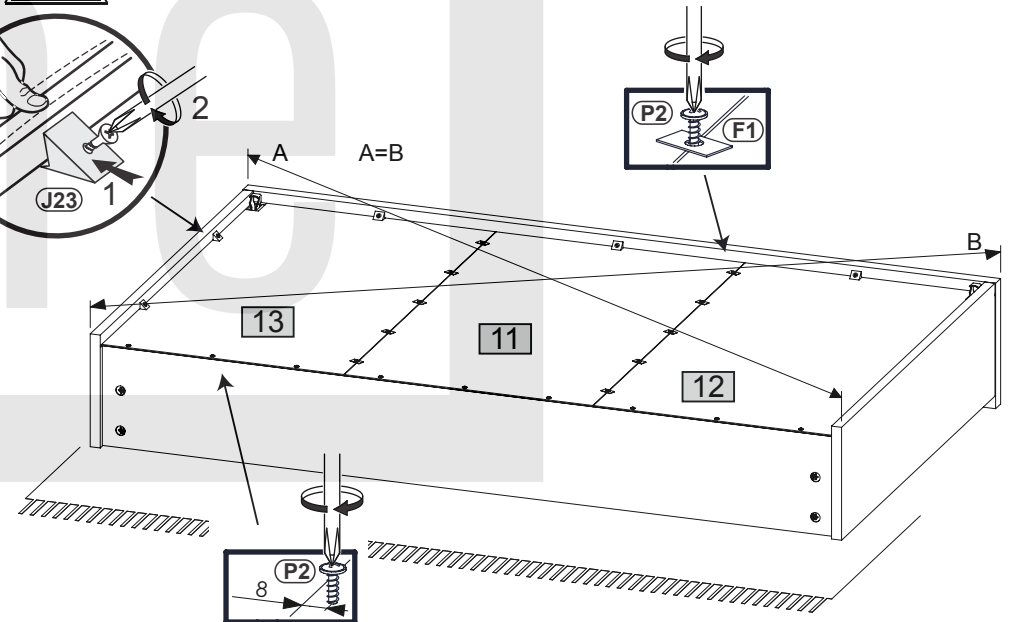
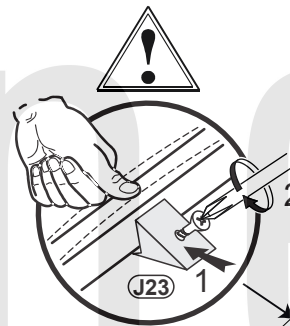
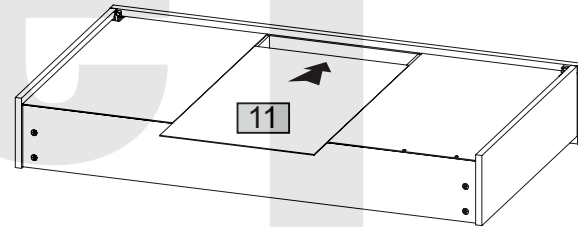
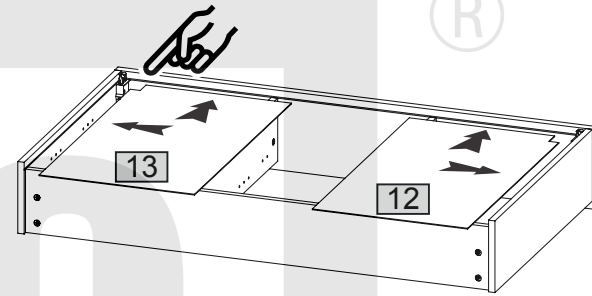
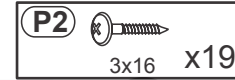
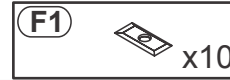
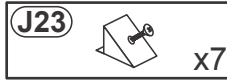

5

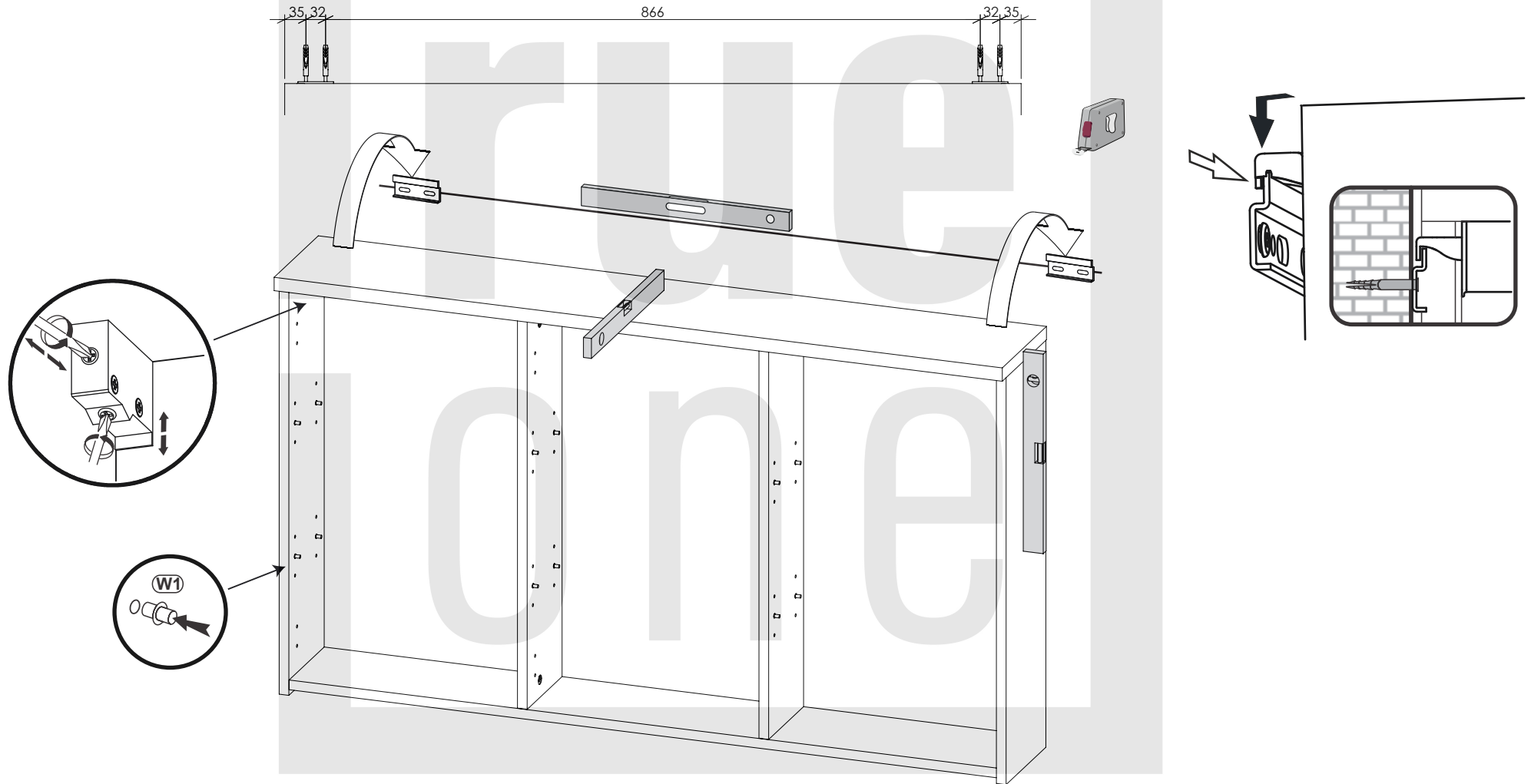
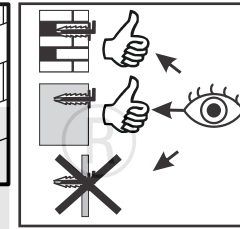
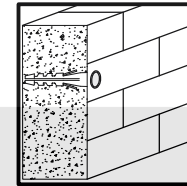
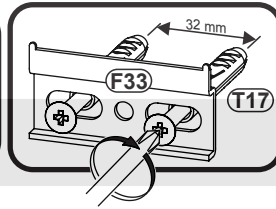
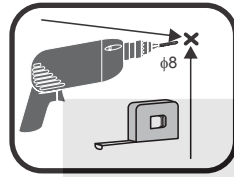
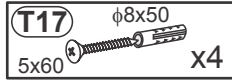
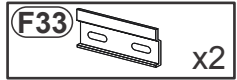

6



7

- Z2c  x4
- S9  4x16 x12
- Z3c  x2

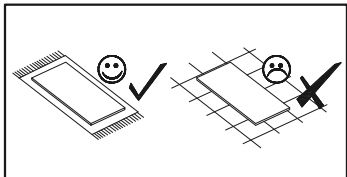
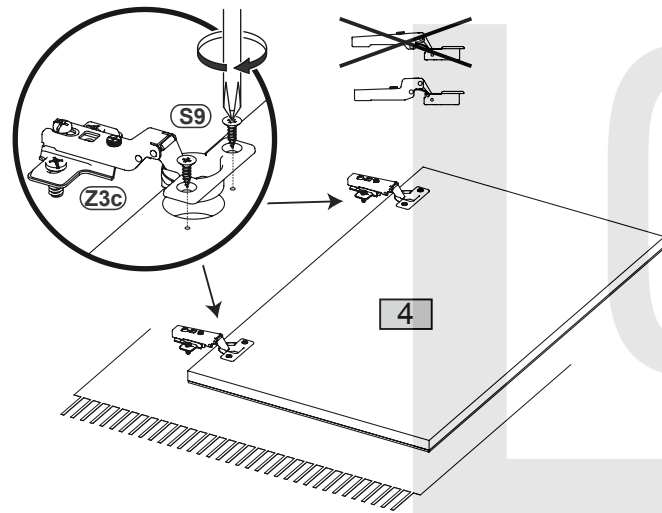
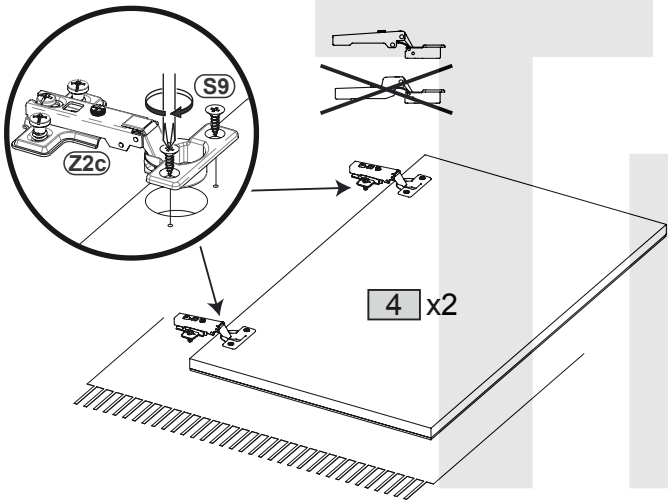

8

- C2  φ 20 x10

