

FJORD

NWT90

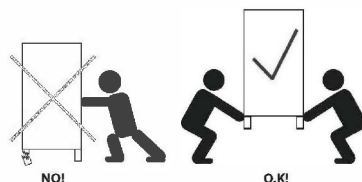
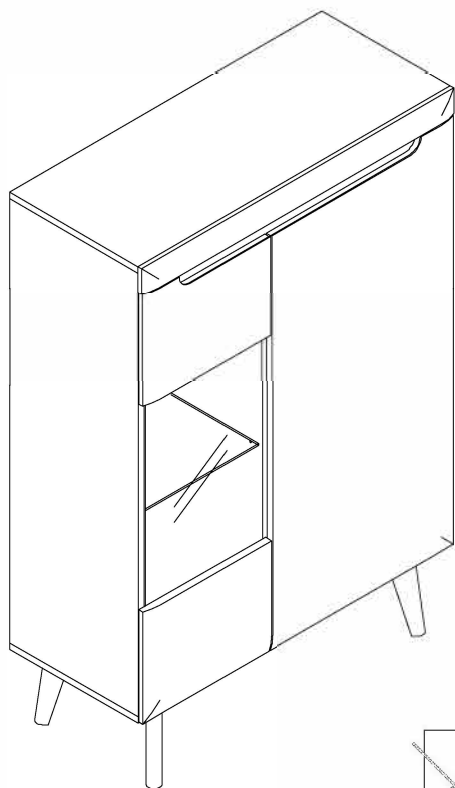

31.8.2017

- D** Montageanleitung
- FR** Notice de montage
- NL** Handleiding voor de montage
- CZ** Montážní návod
- HU** Szerelési útmutató
- TR** Montaj talimatı

- GB** Assembly Instructions
- IT** Istruzioni di montaggio
- PL** Instrukcja montażu
- SK** Návod na montáž
- RO** Instrucțiuni de montaj
- RU** Инструкции по монтажу

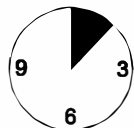
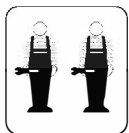

20 min.

1

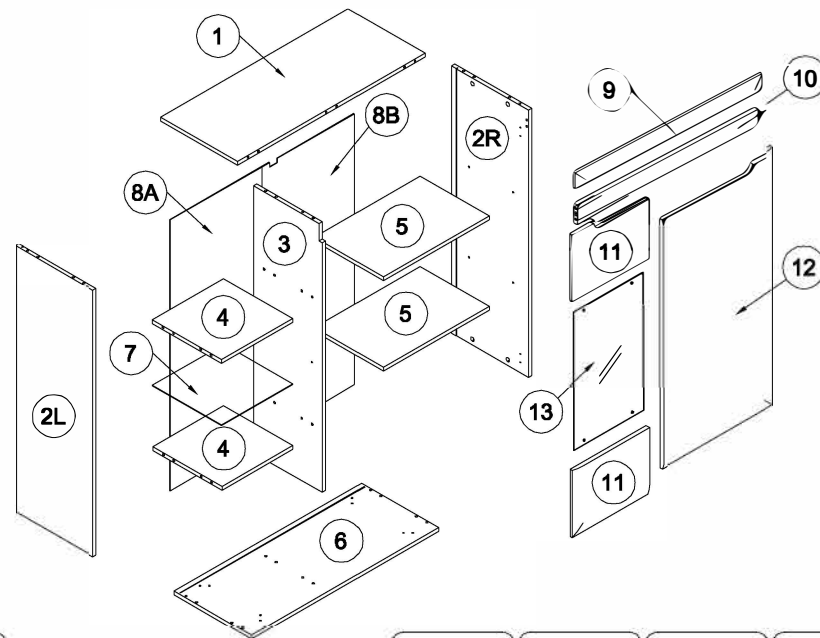

ZA x1	ZC x8	NA 4x13 x1	TB x1	TA x1
C x23	Z x23	HD x8	NGD x4	N 3x20 x14
X x14	ZE x4	Z x8	B x23	A 8x32 x27
H 6,3x13 x10	R x5	PC x5	NC 4x16 x4	ND 3,5x16 x10
ZD x4				

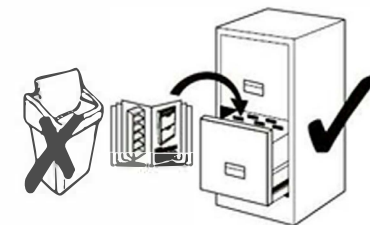
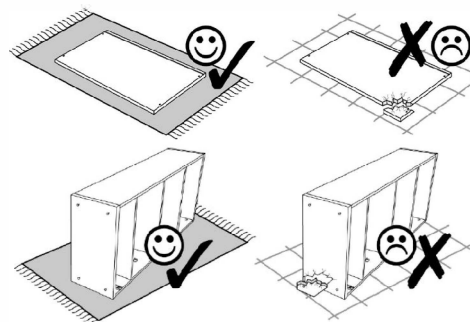

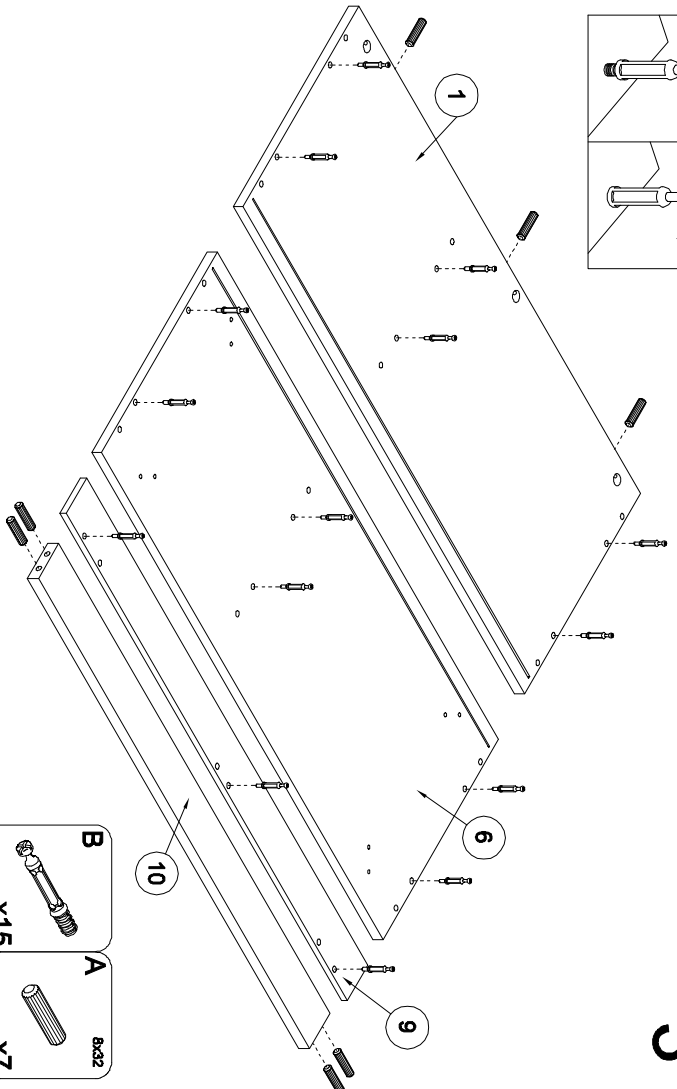
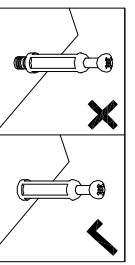

2

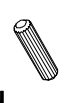

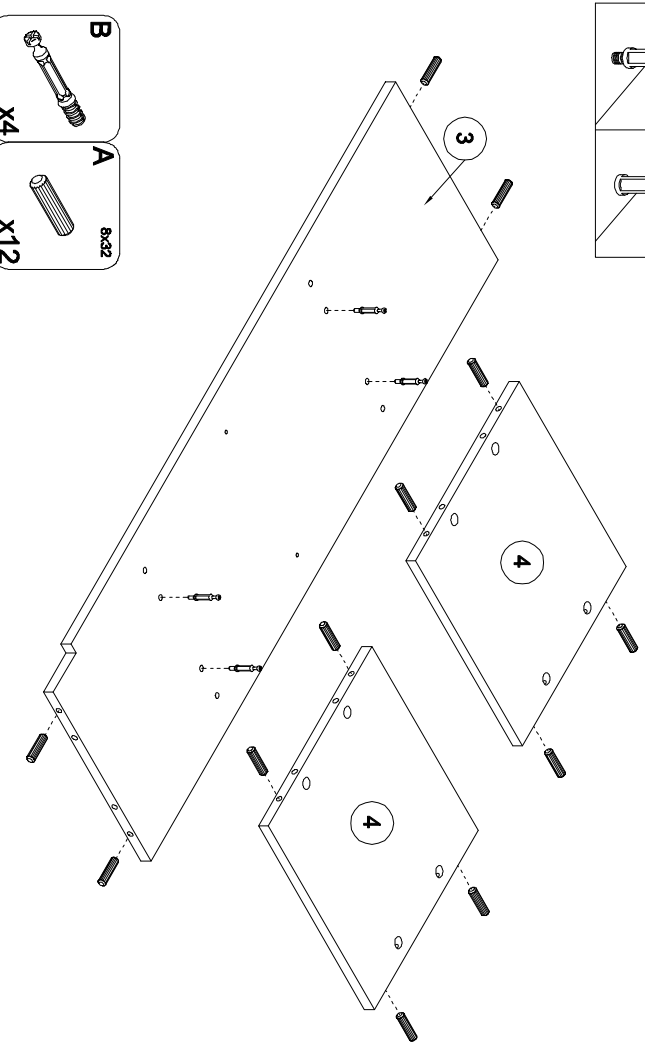
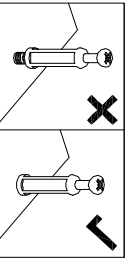



- | | |
|---|--|
| B | A |
|  |  |
| X15 | 8x32
X7 |

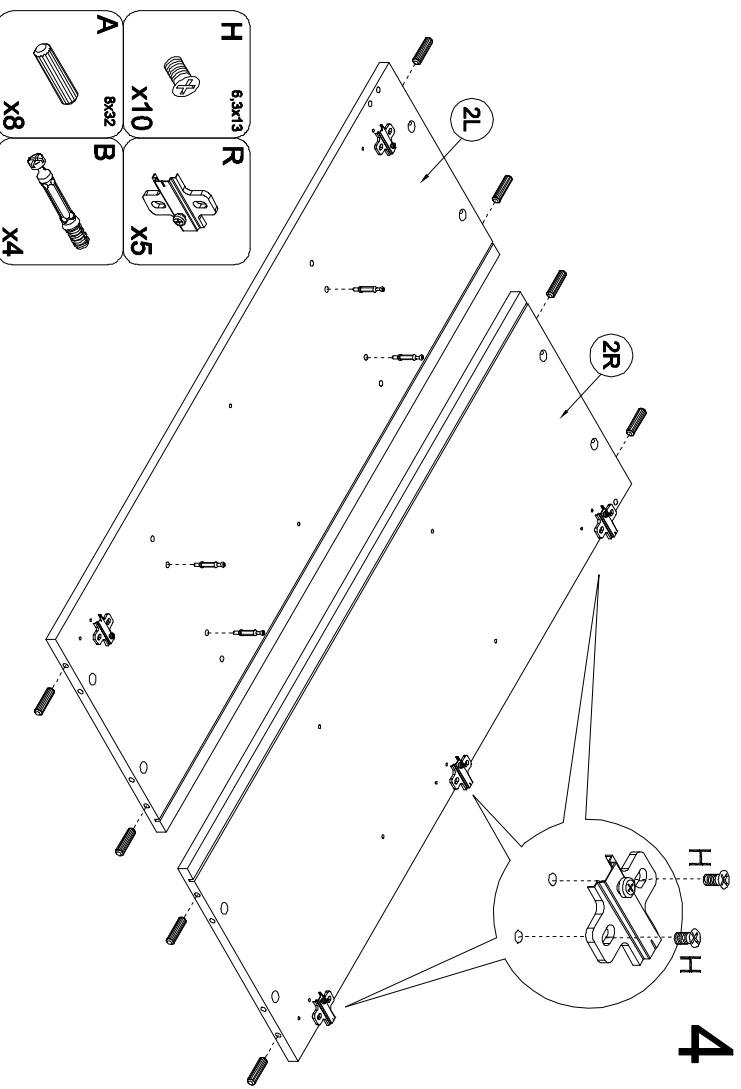

- | | |
|---|---|
| B | A |
|  |  |
| X4 | 8x32
X12 |





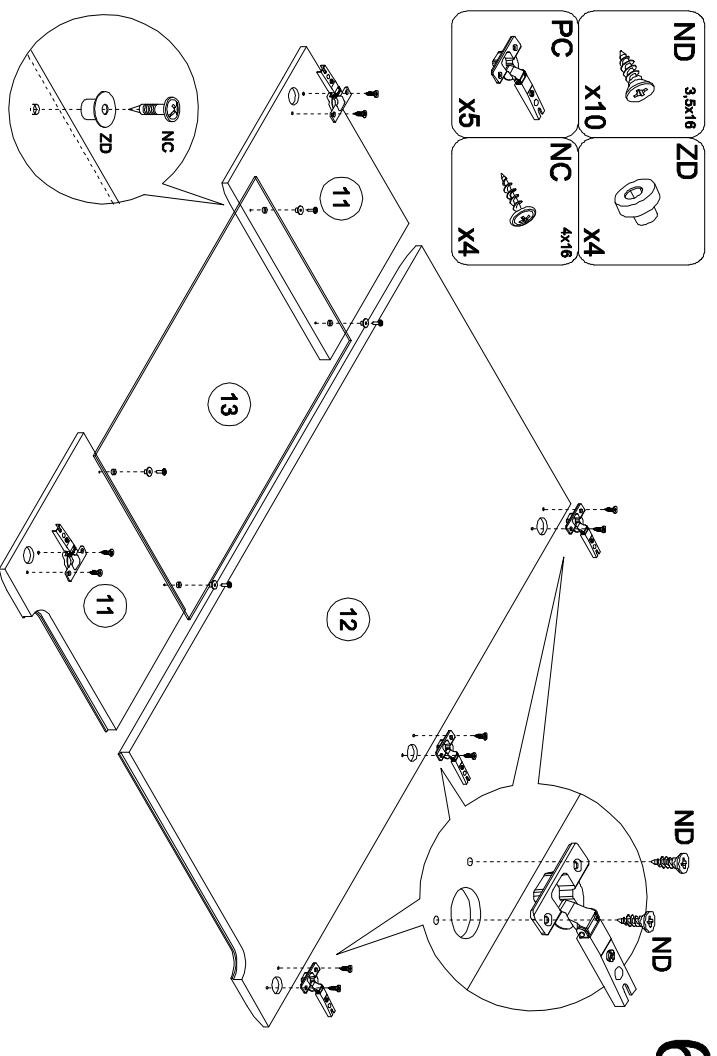

- | | |
|--|---|
| H | R |
|  |  |
| 6.3x13
X10 | X5 |
| A | B |
|  |  |
| 8x32
X8 | X4 |

5

€



- | | |
|---|---|
| ND | ZD |
|  |  |
| 3.5x16
X10 | X4 |
| PC | NC |
|  |  |
| X5 | 4x16
X4 |

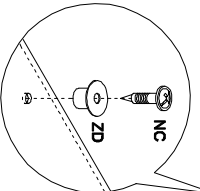

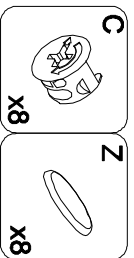
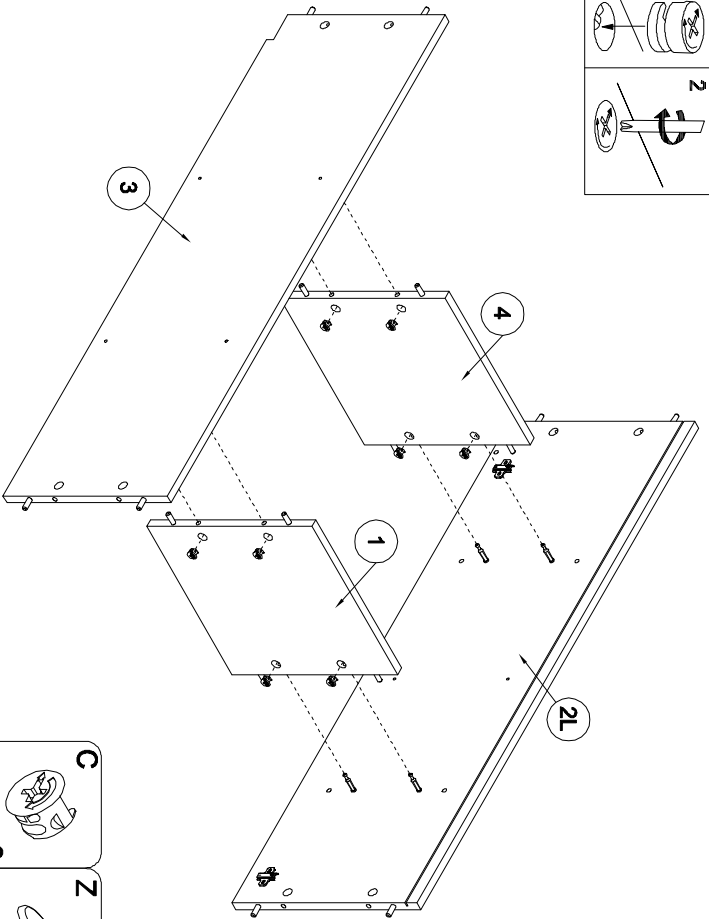
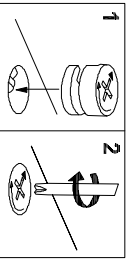

7

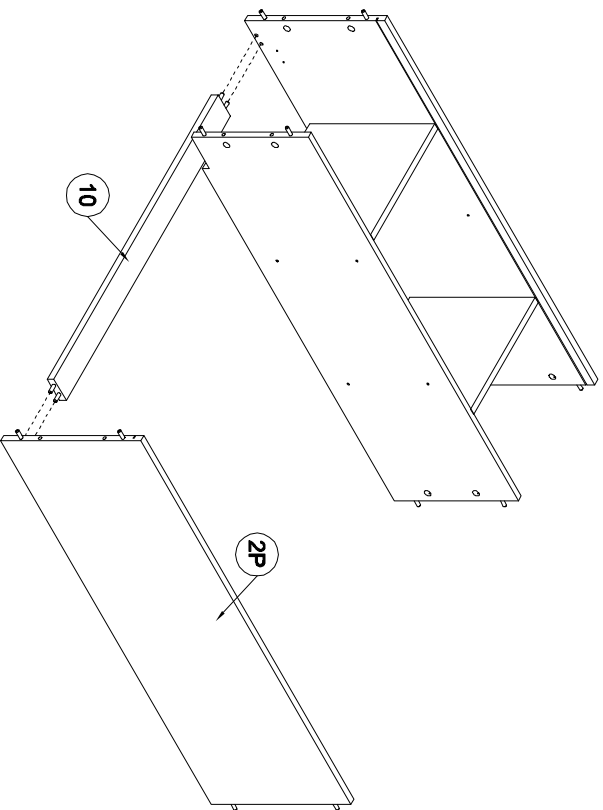

8

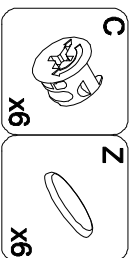
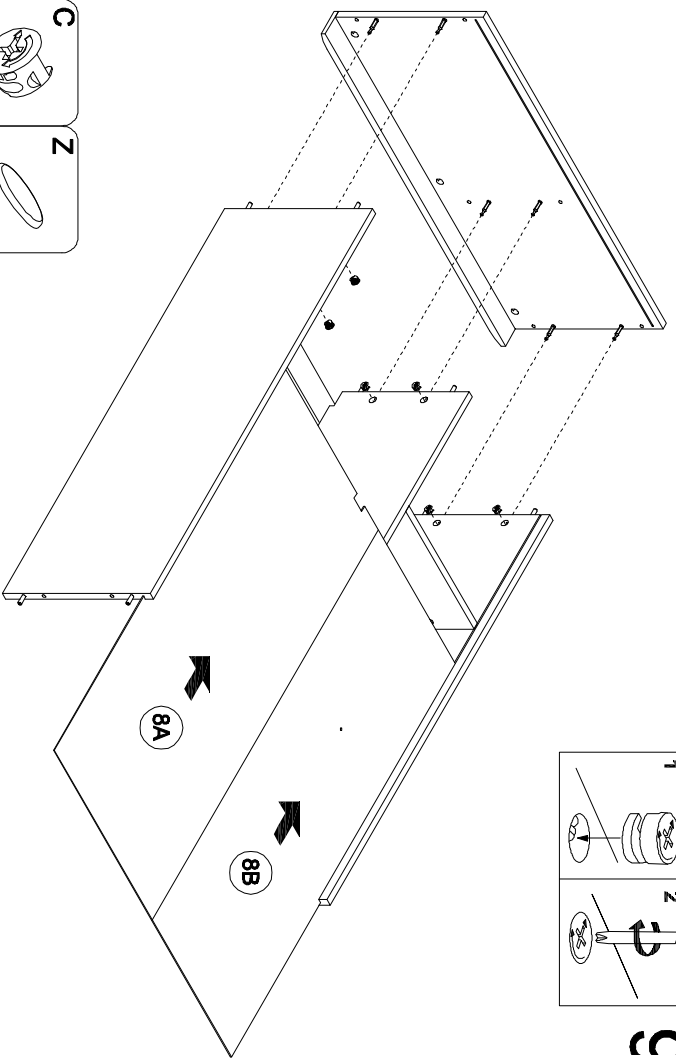
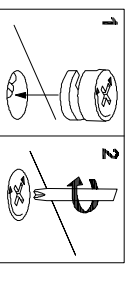

9

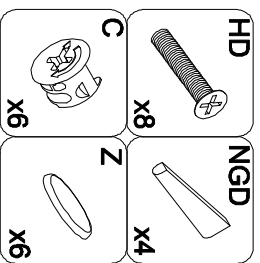
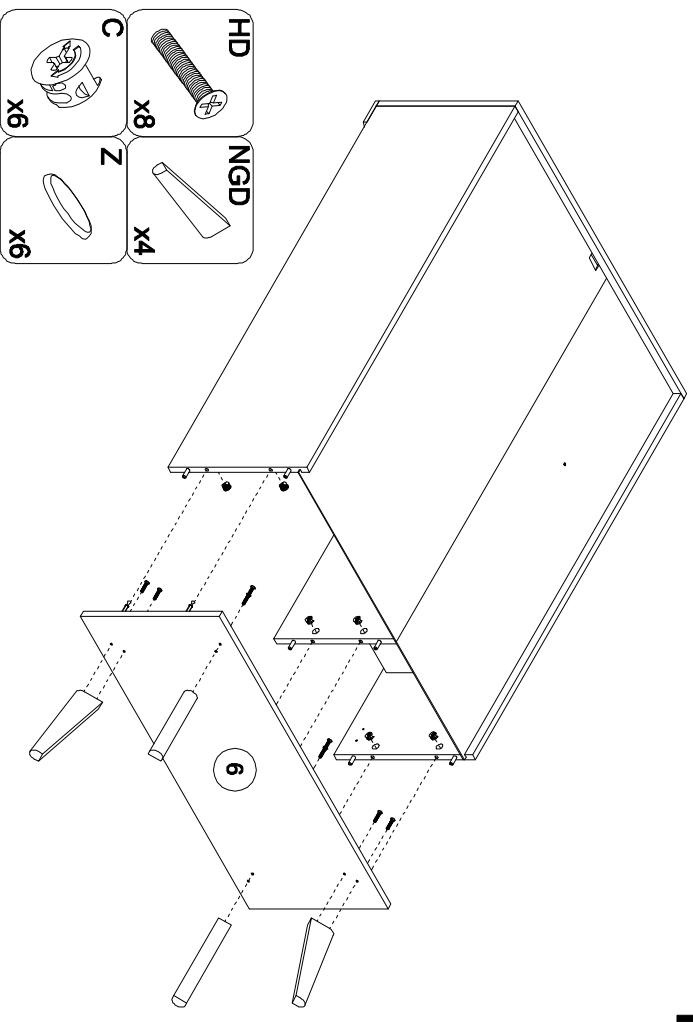

10

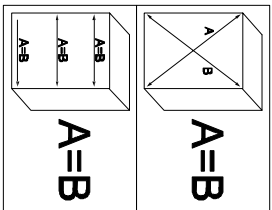



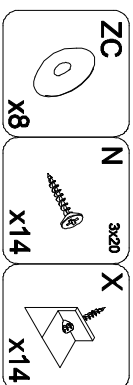
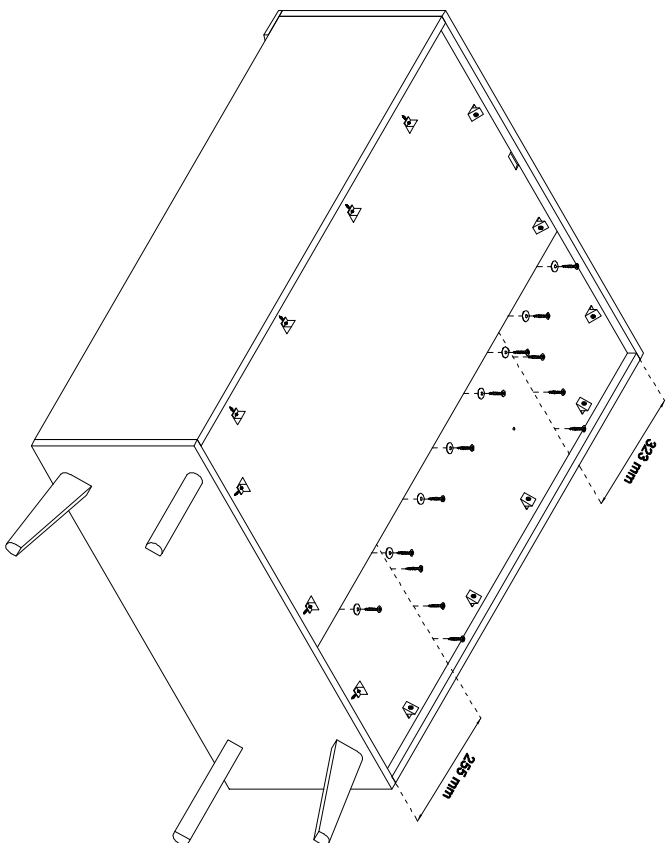

11

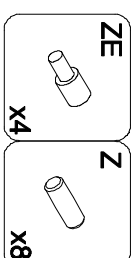
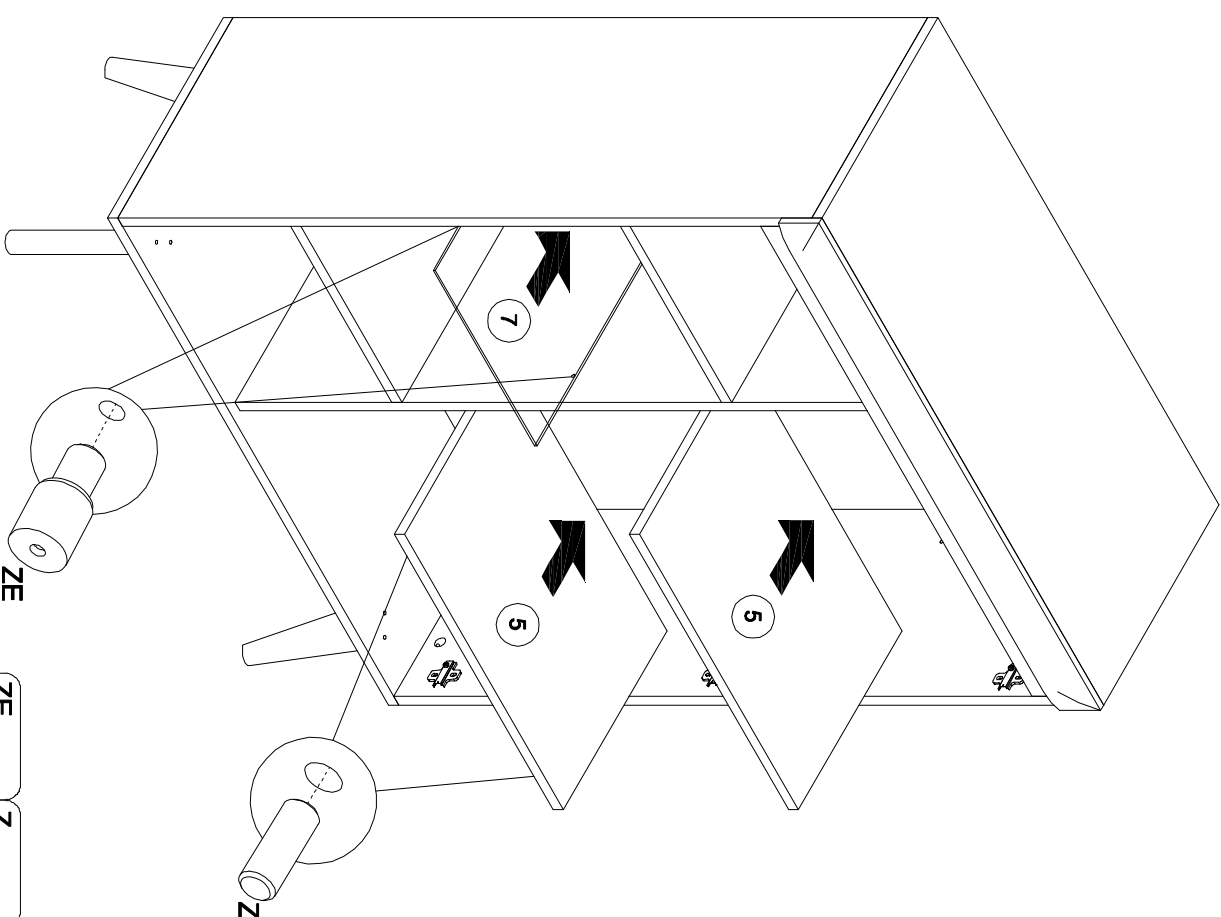

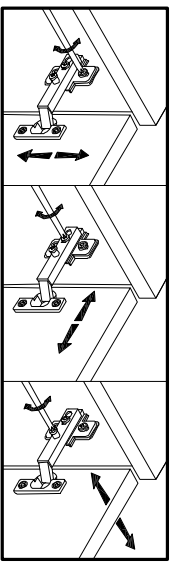
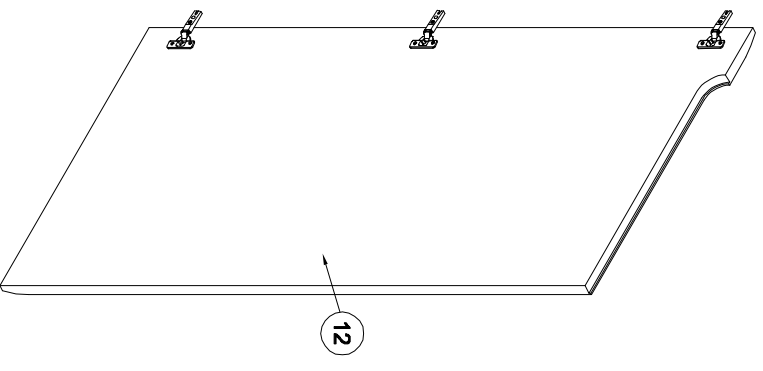
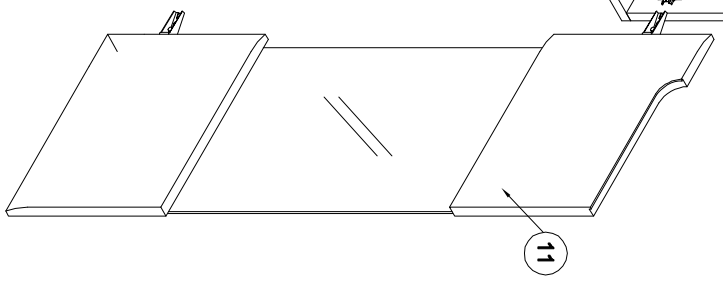
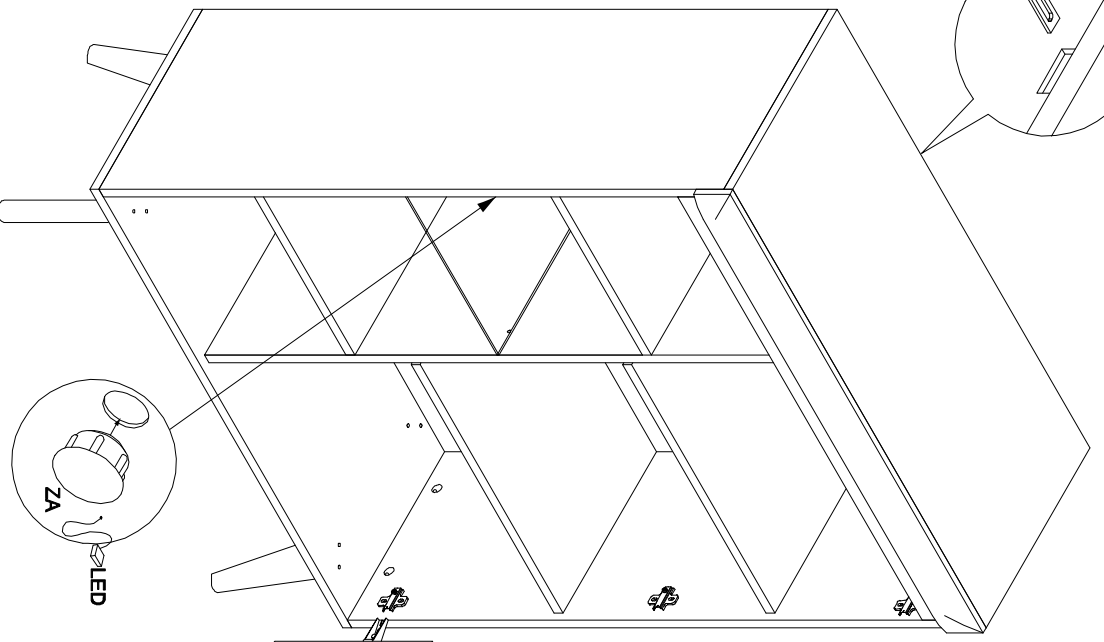
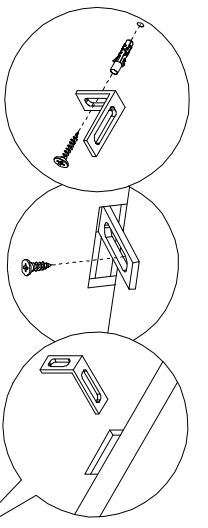
12





- 
NA
 4x13
 x1
- 
TB
 x1
- 
TA
 x1
- 
ZA
 x1