

A	B	C	D
1	S488-0013	1908	446 3/4
2	S488-0014	1908	446 3/4
3	S488-1019	2014	540 1/4
4	S488-1020	2014	540 1/4
5	S488-2006	1060	540 2/4
6	S488-3016	1029	520 2/4
7	S488-3017	1029	520 2/4
8	S488-5501	1029	75 3/4
9	S488-5504	1062	80 3/4
10	S488-5520	1950	80 3/4
11	S488-5521	1950	80 3/4
12	S488-9310	2016	1039 1/4
13	dr-1022	1022	30 2/4

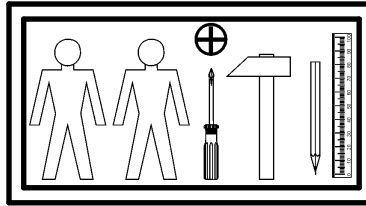

A	B	C	D
14	S488-1021	1622	520 1/1
15	S488-3018	507	514 1/1
16	S488-3019	506	514 1/1
17	dr-502	502	22 1/1

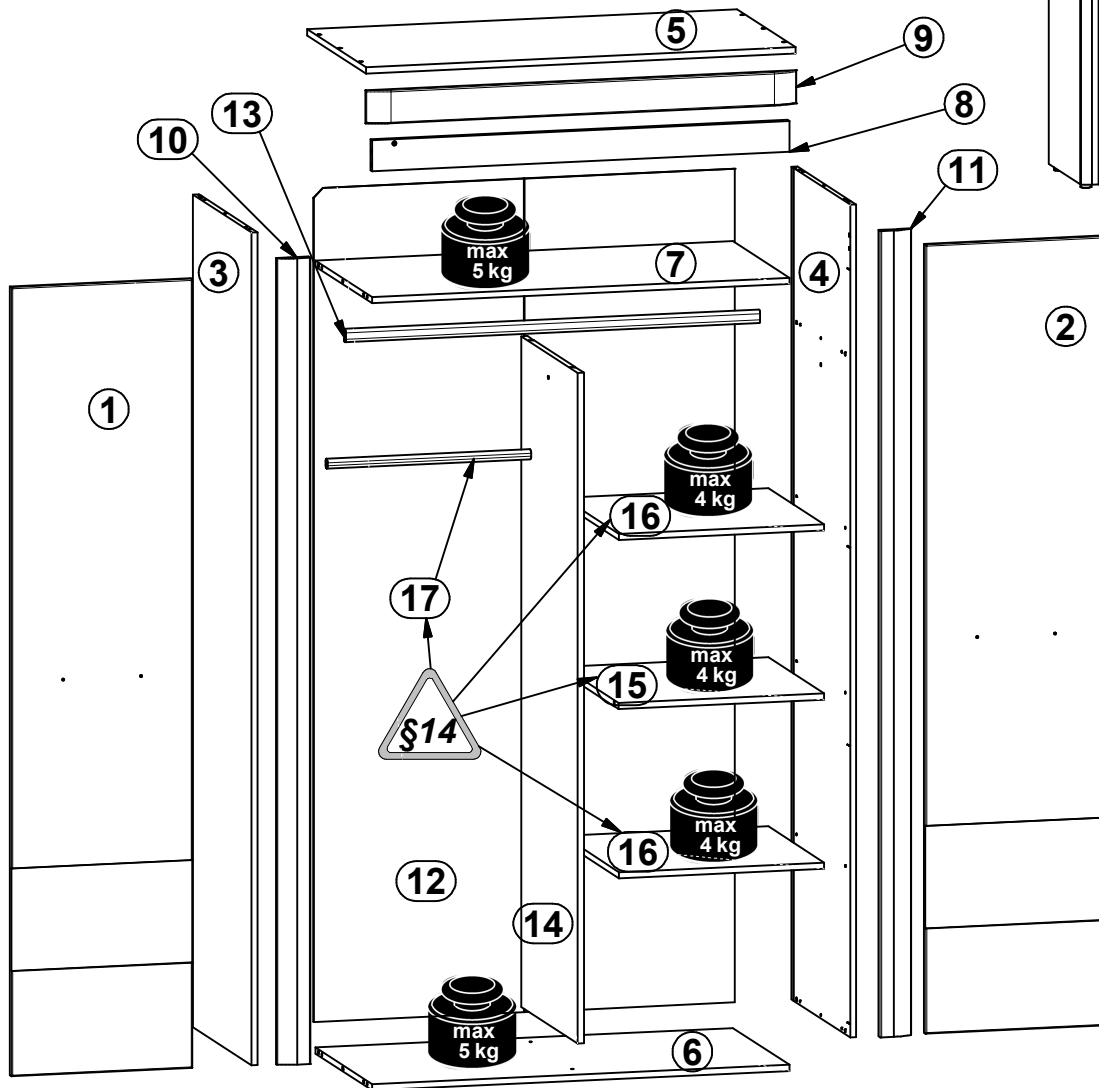
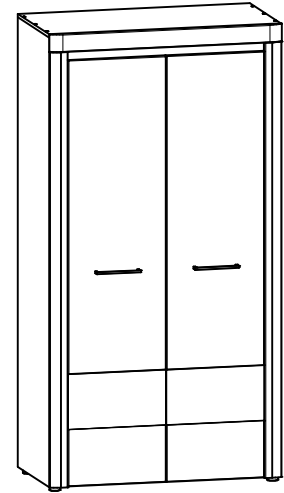

8x a132	2x a133	8x b43	2x c34213	4x d36	8x d37
16x e2	16x f1	4x j30	5x k27	13x l2	2x n158
2x o8319	1x o7019	1x o77160	2x p1	3x p15	40x p38
10x p55	12x r1	12x r42	6x s68	1x z1	1x n2611
					16x p51
					3x o77116
					6x e1



8x d1
8x r36
8x r37

1 

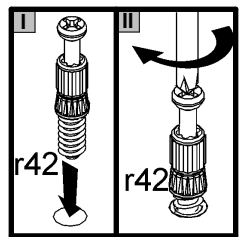
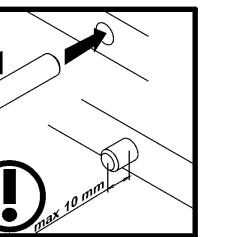
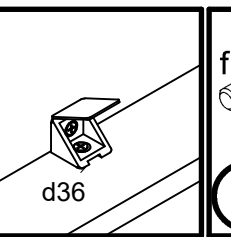
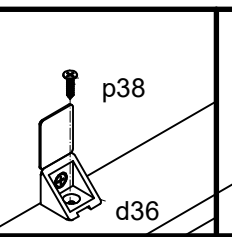
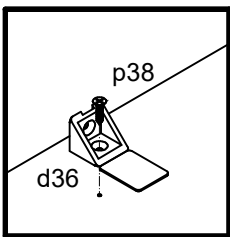
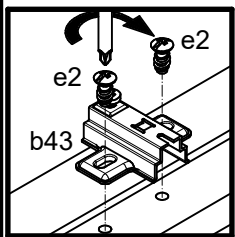
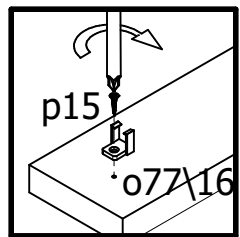
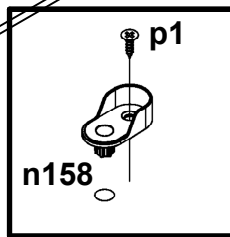
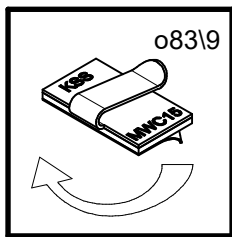
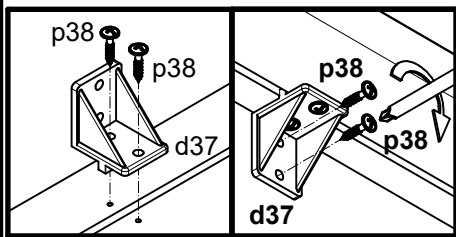
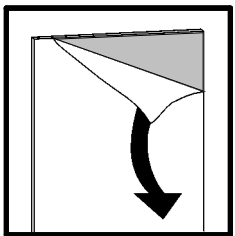
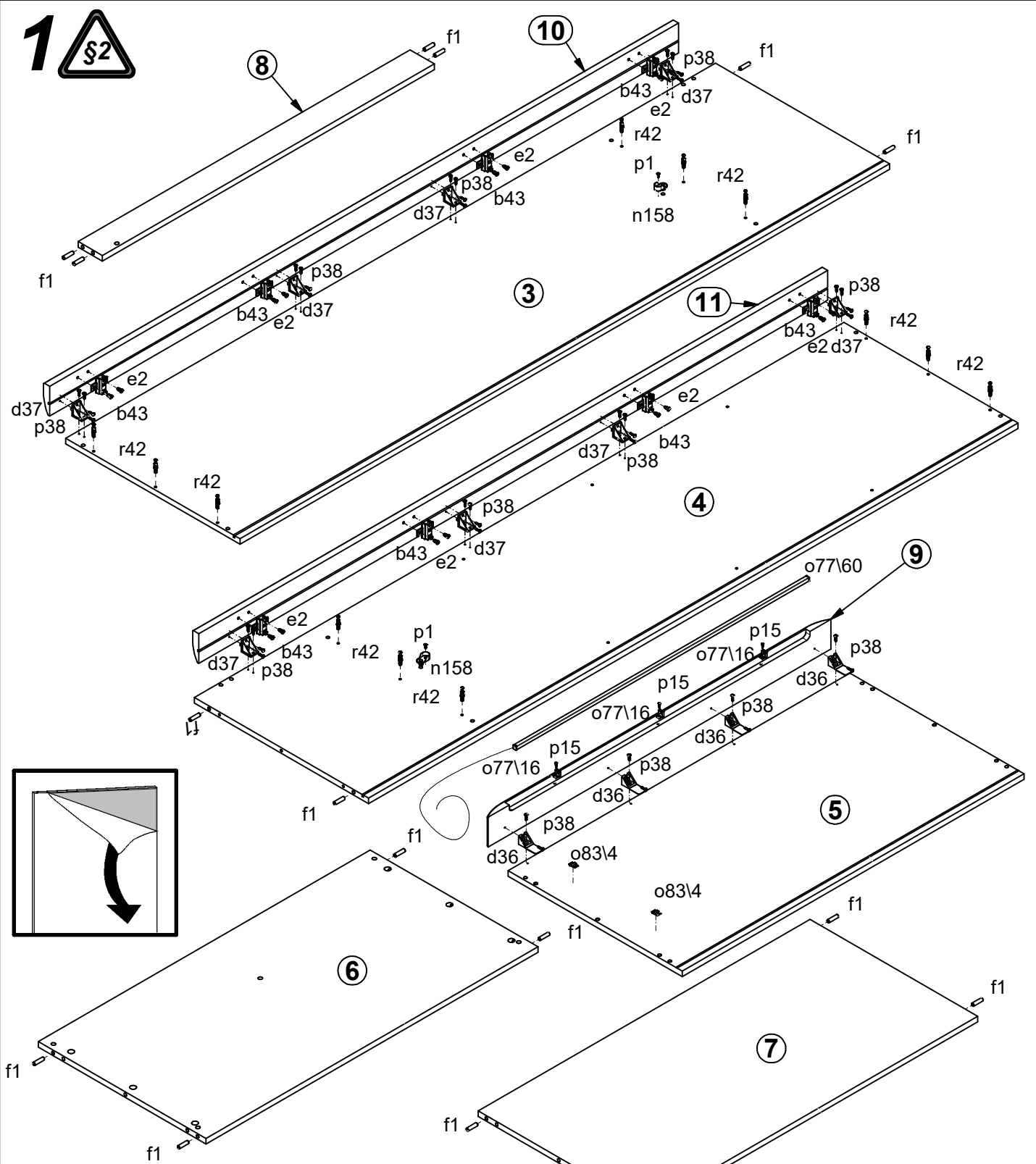

2 §6

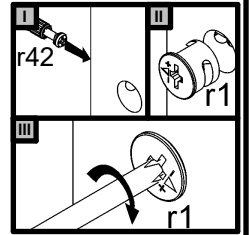
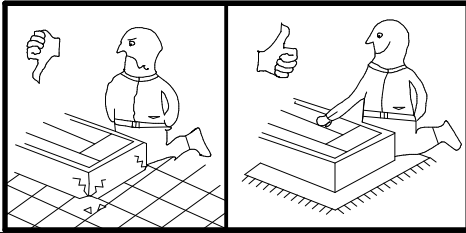
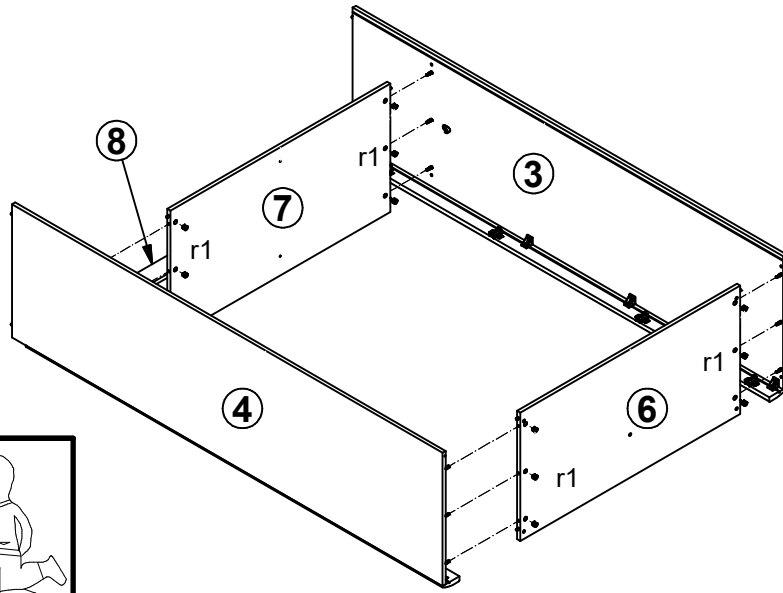

3 §6

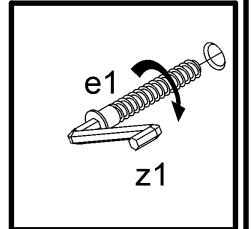
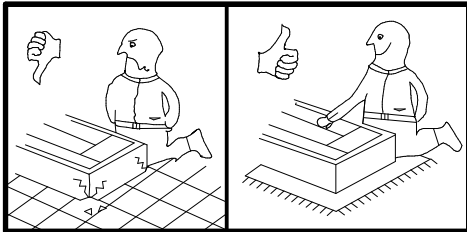
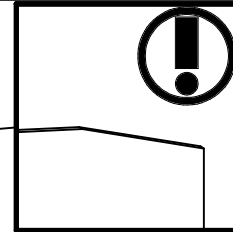
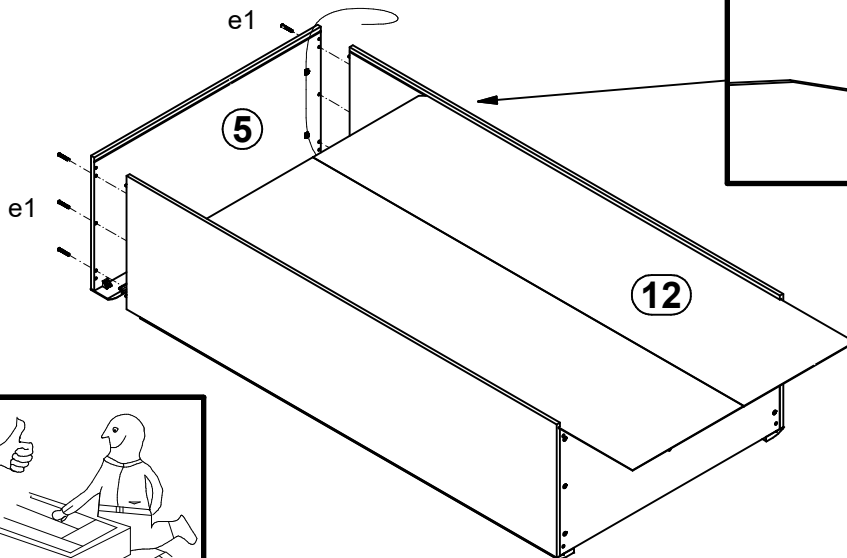

4 §6

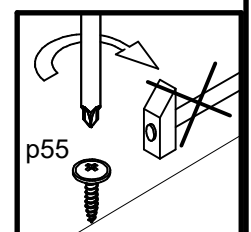
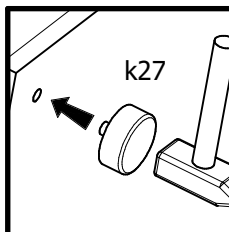
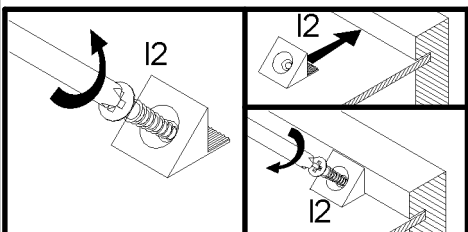
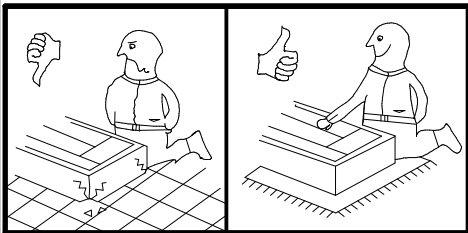
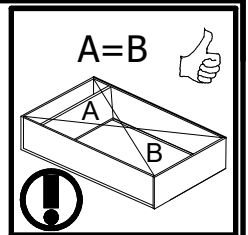
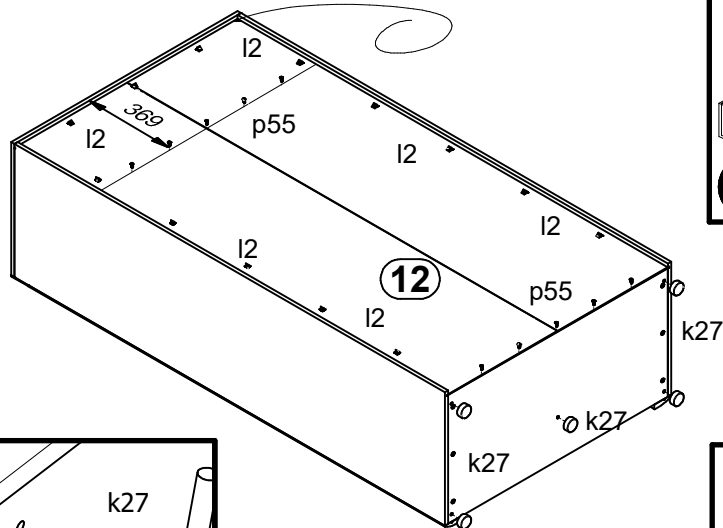

5

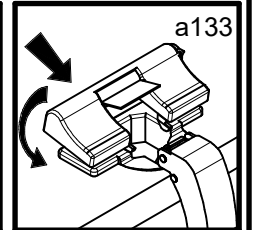
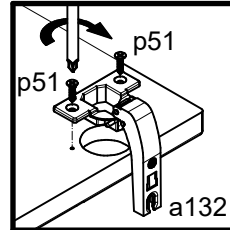
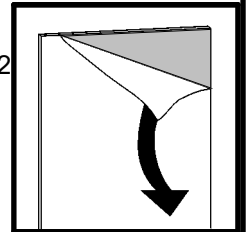
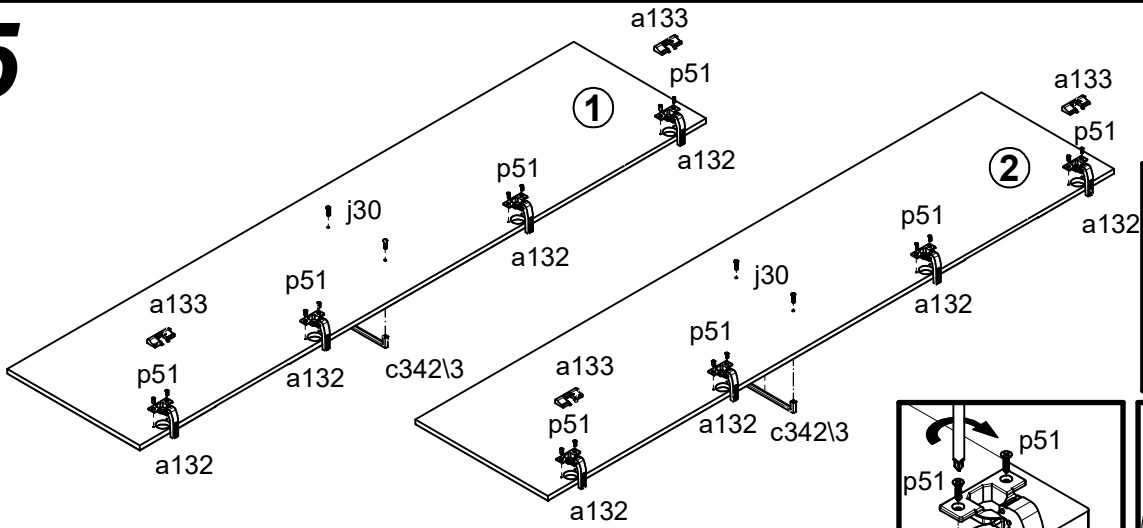

6

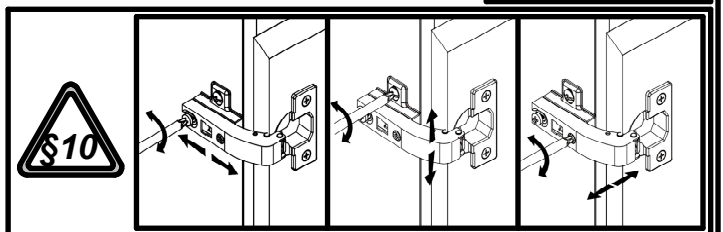
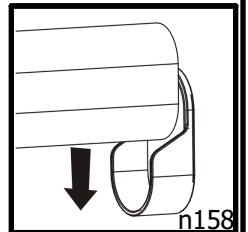
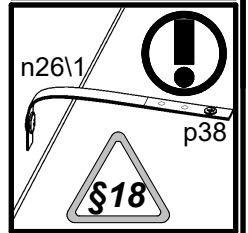
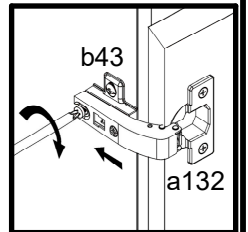
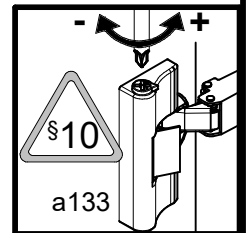
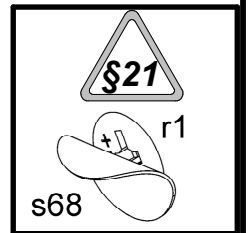
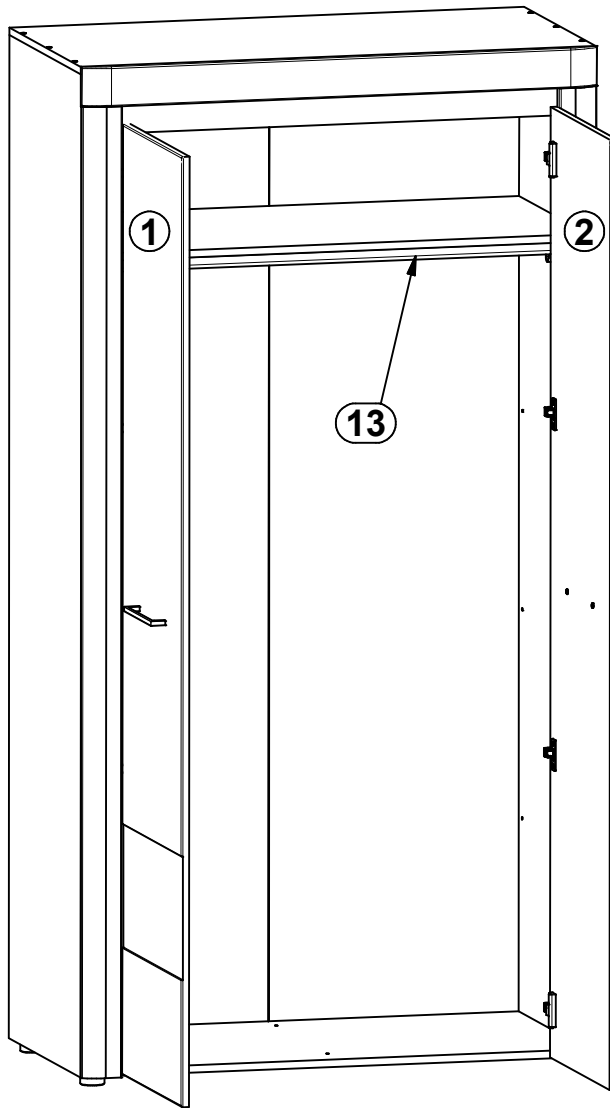

7

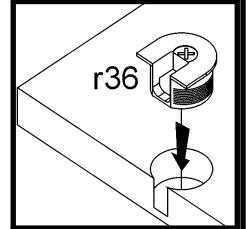
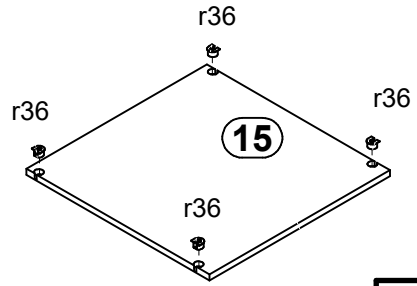
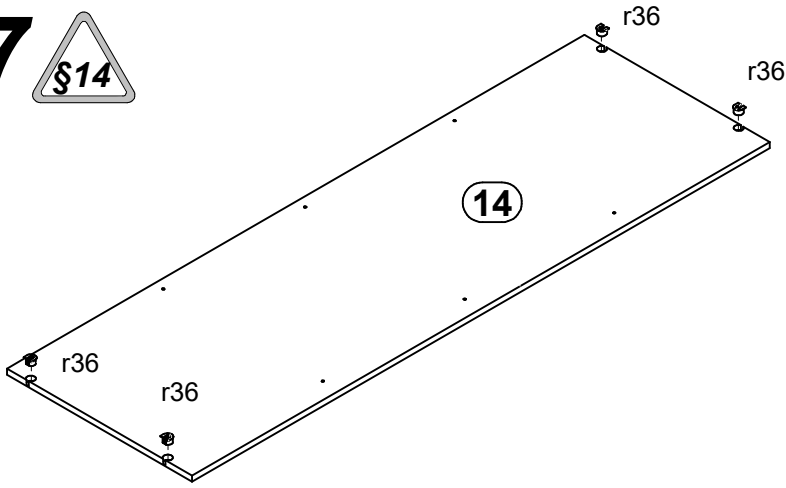

8

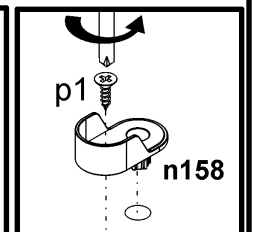
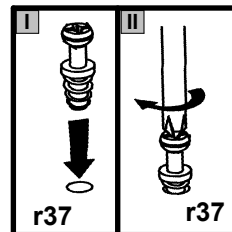
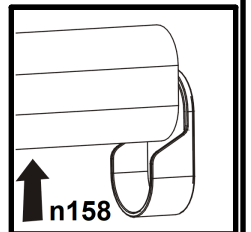
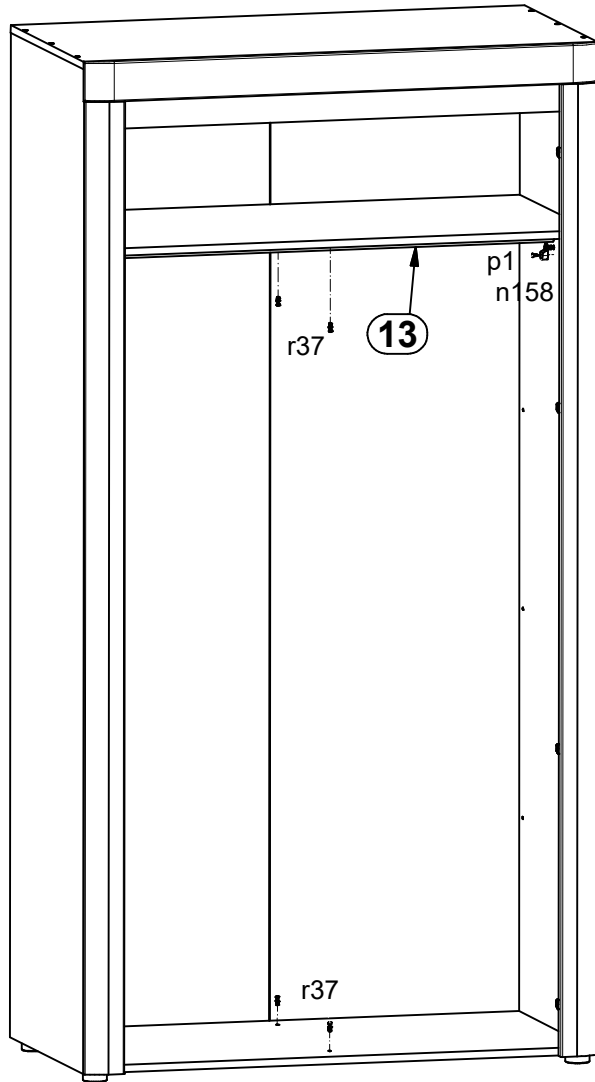

9

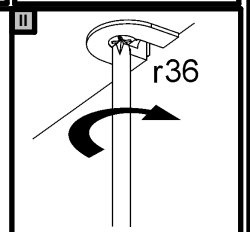
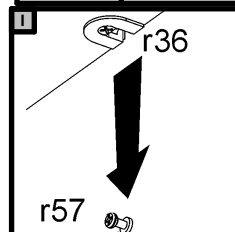
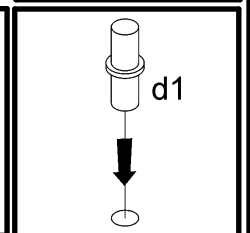
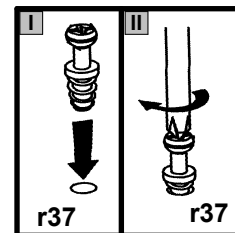
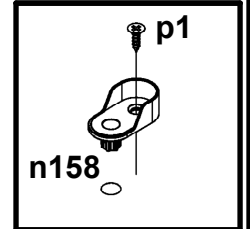
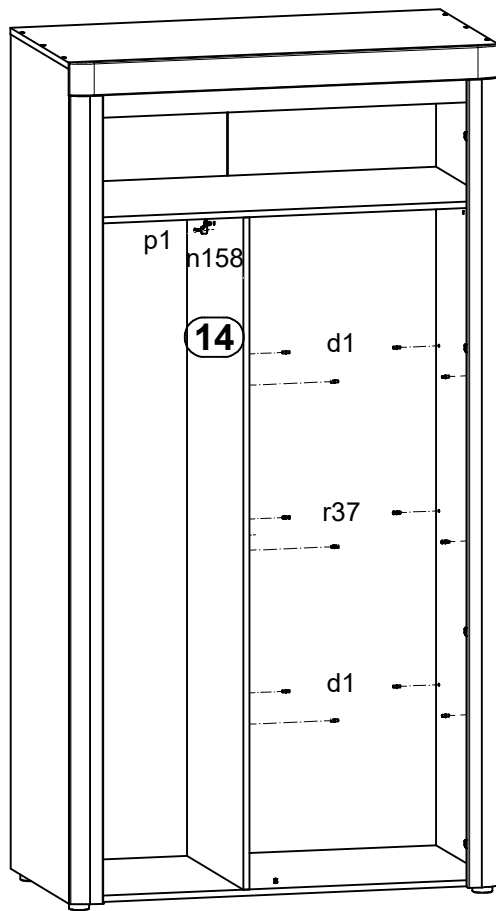

10

