

# SPRING - SZAFKA

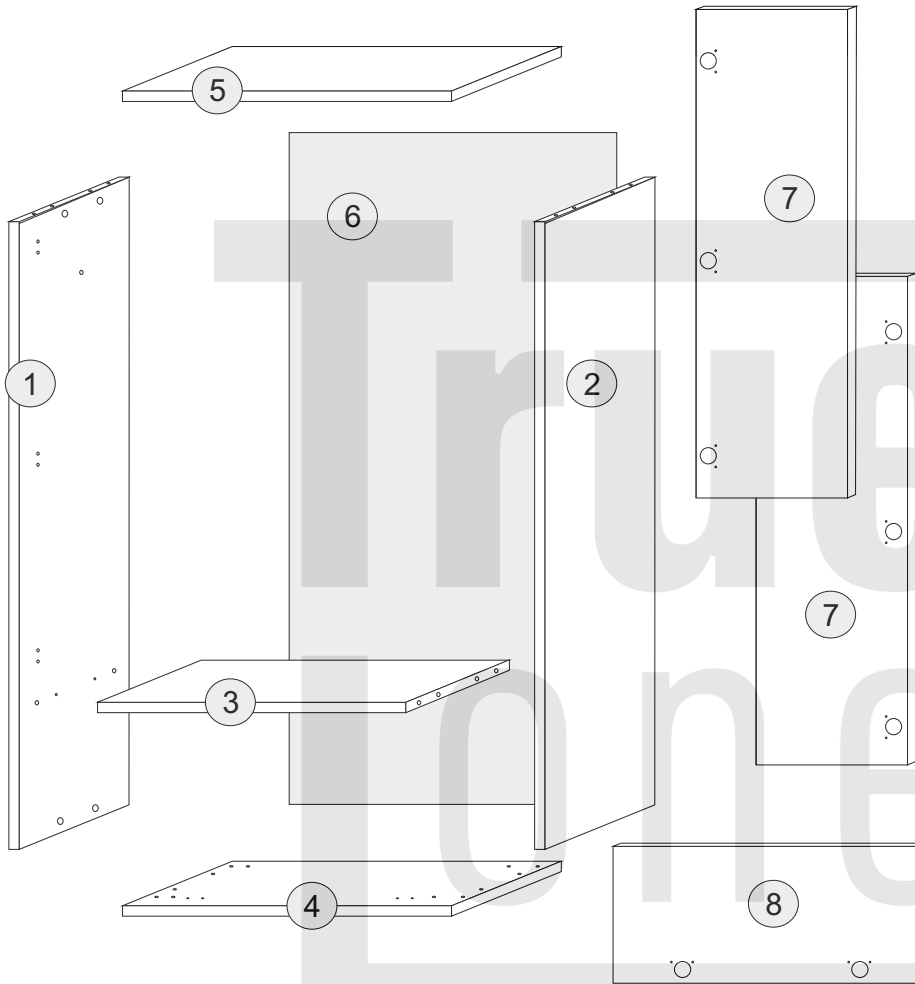

(PL) Instrukcja montażu  
 (D) Aufbauanleitung  
 (GB) Assembly instruction  
 (SK) Návod na montáž

Karta gwarancyjna  
 der Garantieschein  
 Guarantee certificate  
 Záručný list

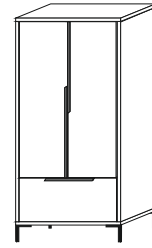

lp	wymiar	ilość
1	1640x500	1
2	1640x500	1
3	868x481	1
4	902x500	1
5	902x500	1
6	1670x449	2
7	1341x429	2
8	862x290	1

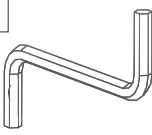
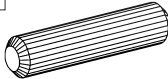
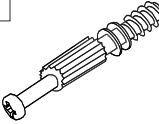
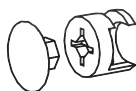
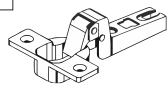
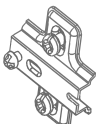
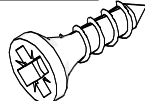
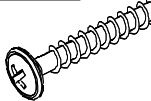
## Akcesoria - Accessories - die Accessoires

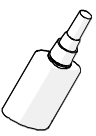
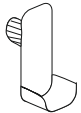
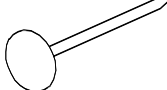
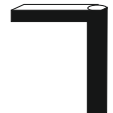
A	 x1	B	 x12	C	 x12	D	 x12	E1	 x8
E2	 x8	F 3.5x13	 x16	G 4x25	 x6	H	 x3	L	 x4
J	 x1	K	 x2	M.	 x35	S	 x4		

