

SAMAYA

K-98

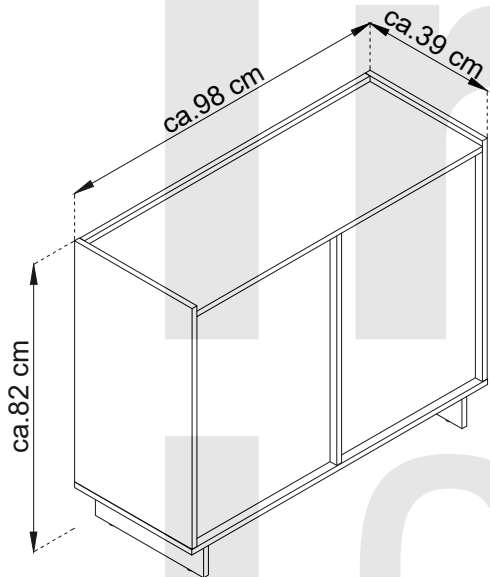

- (D) Montageanleitung
- (FR) Notice de montage
- (NL) Handleiding voor de montage
- (CZ) Montážní návod
- (HU) Szerelési útmutató
- (TR) Montaj talimatı
- (E) Instrucciones de montaje
- (GB) Assembly Instructions
- (IT) Istruzioni di montaggio
- (PL) Instrukcja montaży
- (SK) Návod na montáž
- (RO) Instrucțiuni de montaj
- (RU) Инструкции по монтажу

PIASKI
SINCE 1989

Fabryka Mebli PIASKI Henryk Kaczorowski sp. z o.o.
PIASKI 1C, 63-645 Łęka Opatowska
gpsr@piaski.com.pl

23.03.2026

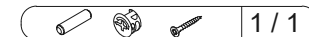
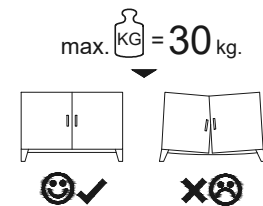
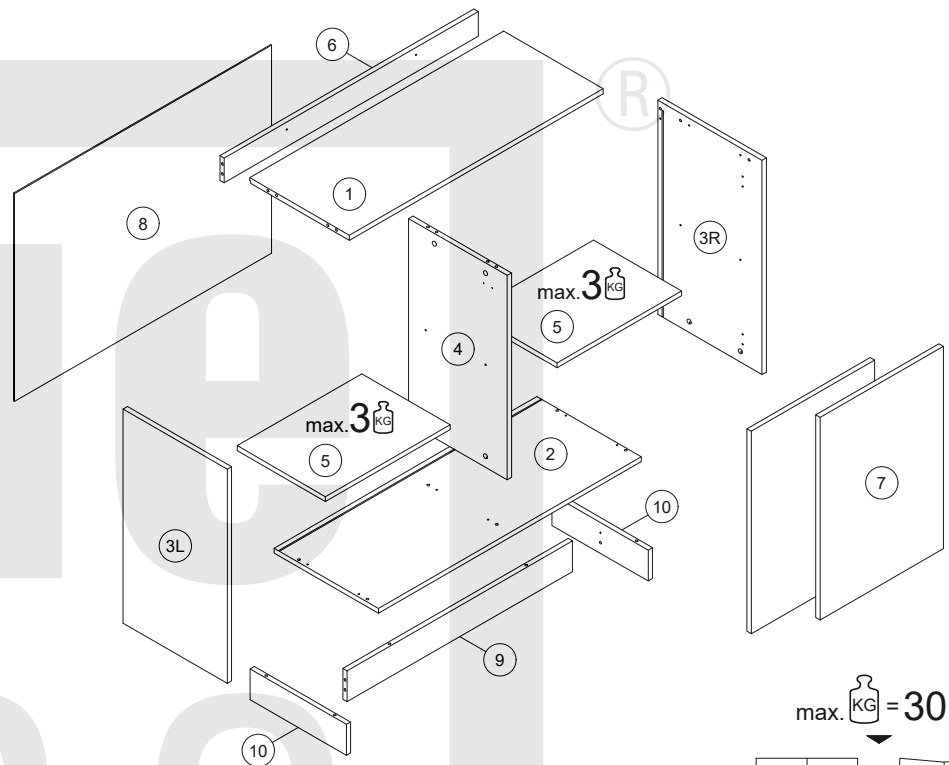

1	950	373	16	x1	1 / 1
2	983	390	16	x1	1 / 1
3L	694	390	16	x1	1 / 1
3R	694	390	16	x1	1 / 1
4	662	369	16	x1	1 / 1
5	466	330	16	x2	1 / 1
6	950	80	16	x1	1 / 1
7	656	461	16	x2	1 / 1
8	962	674	2.5	x1	1 / 1
9	843	100	16	x1	1 / 1
10	360	100	16	x2	1 / 1

A	8x32	B	x22	C	x18	GLUE	x1	H0	x4
KG	x2	N	3x20	ND	3,5x16	NS	3,5x13	ST	x1
SPO	x5	WH	x4	X	x10	Z	x8	ZZ	x8

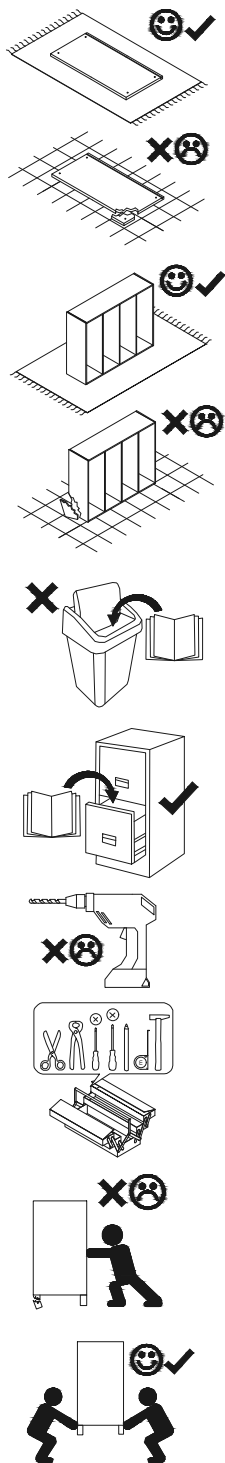

! Uwaga • Upozornění • Achtung • Attention • Caution • Figyelem
 Attensione • Opgelet • Внимание • Atentie • Upozornenie • Dikkat !

! Uwaga • Upozornění • Achtung • Attention • Caution • Figyelem
 Attensione • Opgelet • Внимание • Atentie • Upozornenie • Dikkat !

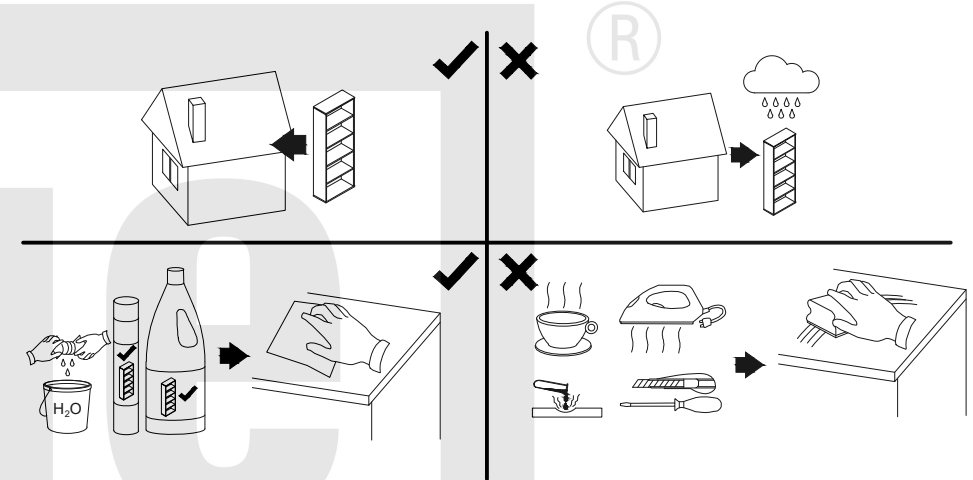
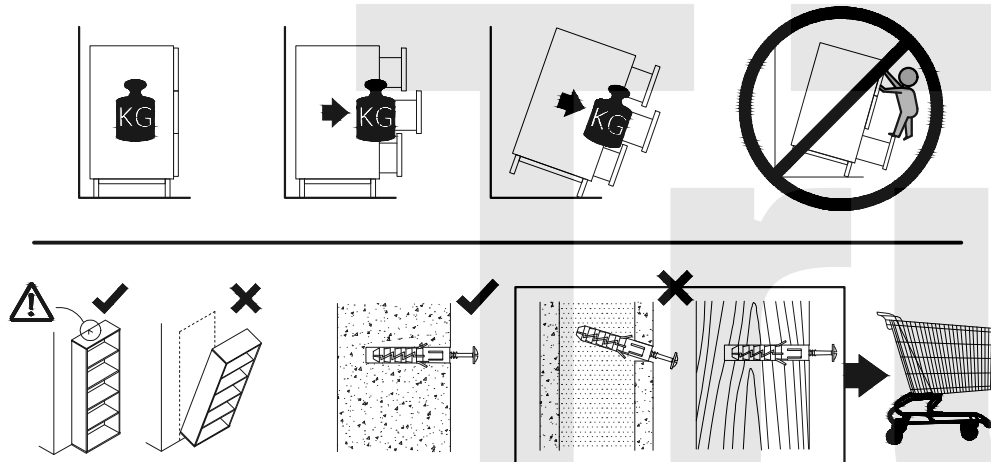

PL	Mocowanie do ściany jest jednocześnie zabezpieczeniem przed przewróceniem - koniecznie zamontować! Do niektórych rodzajów ścian koniecznie zastosować specjalne kolki mocujące.
CZ	Montáž na stěnu slouží jako ochrana proti převrnutí - bezpodmínečně umístěte! U některých typů stěn může být zapotřebí speciální hmoždinka!
DE	Wandbefestigung dient als Kippschutz - unbedingt anbringen! bei einigen Wandtypen kann ein Spezialdübel erforderlich sein!
GB	The wall fastening serves to prevent tipping - be absolutely sure to mount it! For certain wall types, a special wall plug may be necessary!
FR	La fixation murale sert de protection contre le basculement - à installer impérativement! Pour certains types de murs il faut des chevilles spéciales!
NL	De muurbevestiging is ook een anti-kantelbeveiliging - moet worden gemonteerd! Voor bepaalde soorten muren is het nodig speciale bevestigingspluggen te gebruiken.
IT	Il fissaggio alla parete serve da protezione anti-ribaltamento-attaccarla assolutamente! Per alcune strutture di parete può essere necessario un tassello speciale!
HU	A termék a falhoz kel rögzítési, különben az felborulhat! Egyes fal típusoknál speciális tiplőt kell használni!
RU	Обязательно установите крепление на стене во избежание опрокидывания! Для некоторых типов стен может потребоваться специальный дюбель!
RO	Sistemul de fixare la perete servește ca protecție la răsturnare - de montat obligatoriu! Pentru unele tipuri de pereți este posibil să fie necesar un diblu special!
SK	Upevnenie na stenu slúži ako ochrana proti prevráteniu - bezpodmienečne použite! Pre niektoré druhny stein môže byť potrebná špeciálna hmoždinka!
TR	Duvardaki sabitleme, devrilmeye karşı bir emniyet tedbiridir ve mutlaka monte edilmelidir! Bazı duvar tiplerinde bunun için özel bir dübel gerekli olabilir!
E	Fijarlo a la pared también protege contra vuelcos. ¡Asegúrese de instalarlo! Para algunos tipos de paredes, es necesario utilizar pasadores de montaje especiales.

PL	Czyszczenie należy wykonać wyłącznie za pomocą ściereczki lub lekko nawilżonego ręcznika. Nie stosować środków czyszczących do szorowania.
CZ	Čištění je nutné vykonávat výhradně pomocí utěrky nebo lehce navlženého ručníku. Nepoužívejte čističky obsahující abrazivní částice.
DE	Bitte nur mit einem Staubtuch oder leicht feuchtem Lappen reinigen. Keine scheuernden Putzmittel verwenden.
GB	Please only clean with a duster or damp cloth. Do not use any abrasive cleaners.
FR	Le nettoyage se fait uniquement à l'aide d'un torchon ou d'une serviette légèrement mouillée.
NL	Reinigen met een zachte doek of een licht vochtige doek. Geen schurende middelen gebruiken.
IT	Pulire esclusivamente con un panno o un asciugamano umido.
HU	A tisztítás kizárólag törleruha vagy enyhén nedvesített törölköző segítségével végezhető. Súroló hatású tisztítószereket nem szabad használni.
RU	Очищайте от пыли тряпкой или слегка влажной ветошью. Не допускается применение чистящих средств, не предназначенных для ухода за мебелью.
RO	Curățarea trebuie efectuată numai cu o cârpă sau cu un prosop ușor umezit. Nu utilizați agenți de curățare abrazivi.
SK	Čistení je nutné vykonávať výhradne pomocí utierky alebo ľahko zvlhnutým ručníkom. Nepoužívajte čistiace prostriedky obsahujúci abrazívni častice.
TR	Lütfen sadece bir toz bezilye veya hafif nemli yumuşak bir bezle siliniz. Aşındırıcı temizlik malzemeleri kullanmayınız.
E	La limpieza debe realizarse únicamente con un paño o una toalla ligeramente humedecida. No utilizar productos de limpieza abrasivos

1

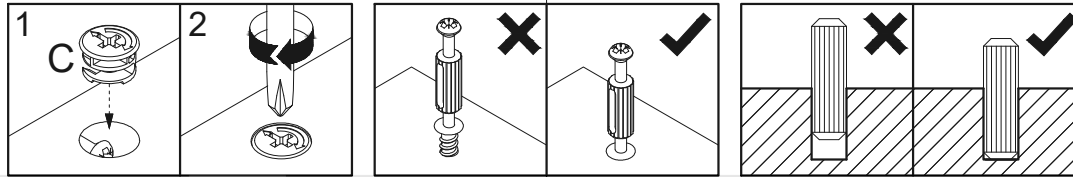

2

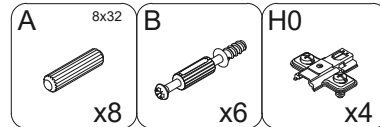
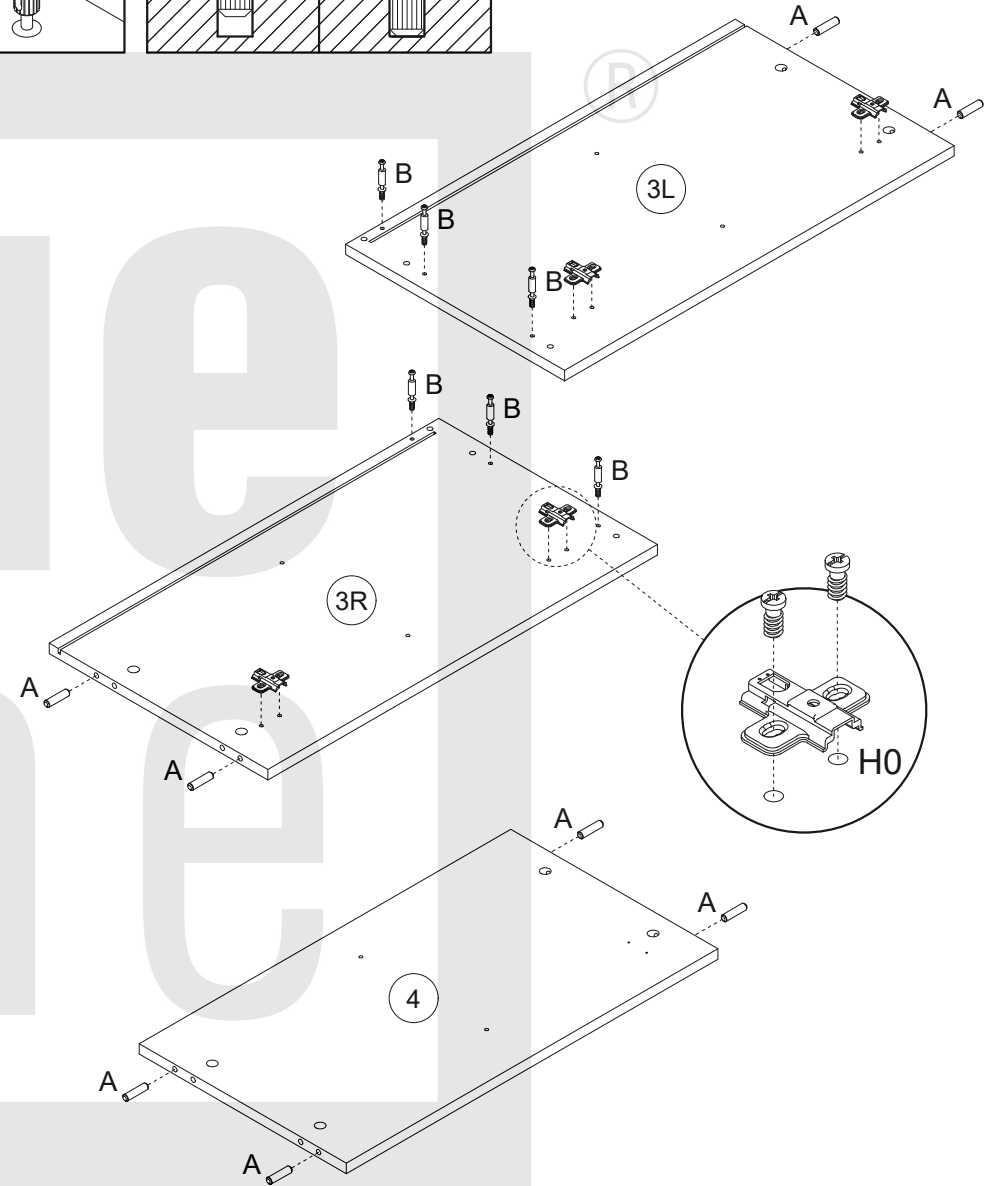
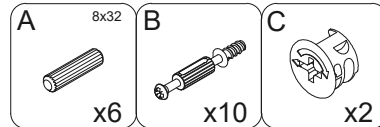
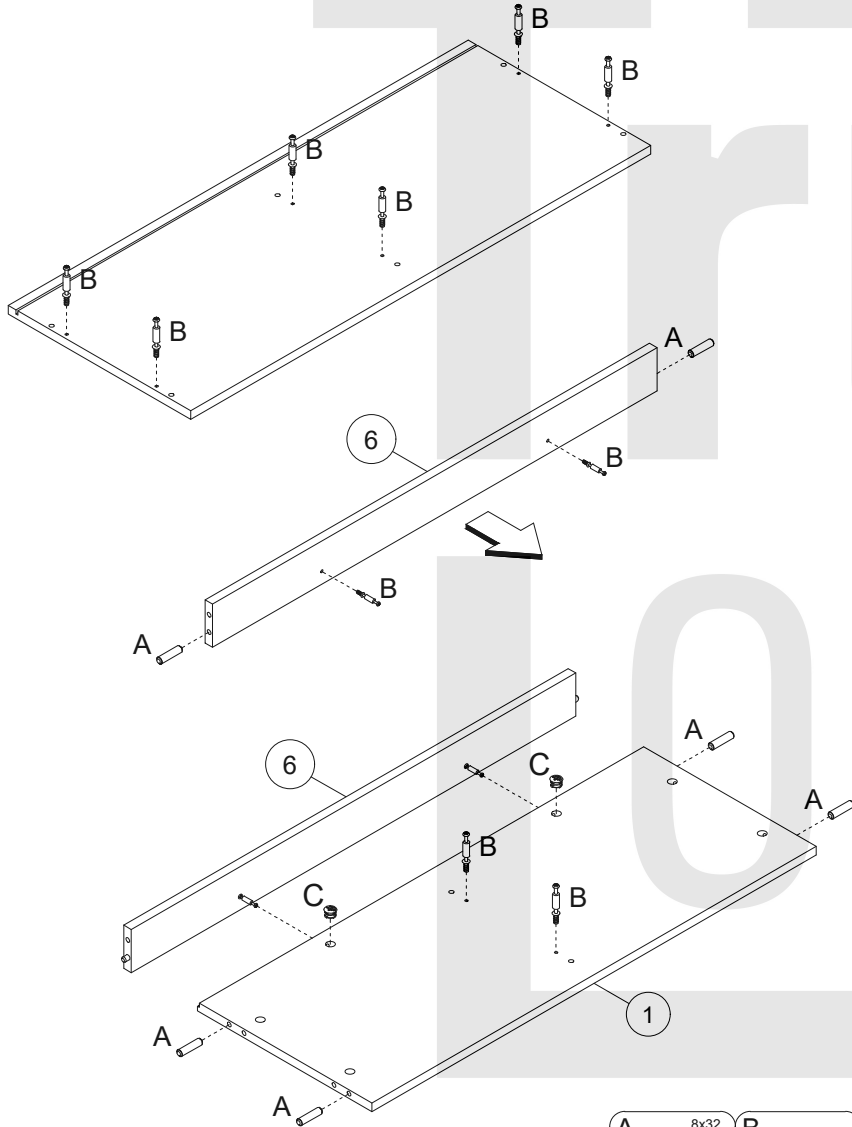

3

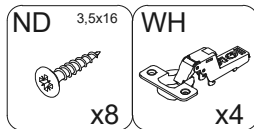
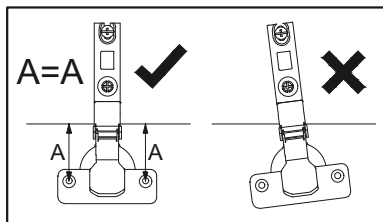
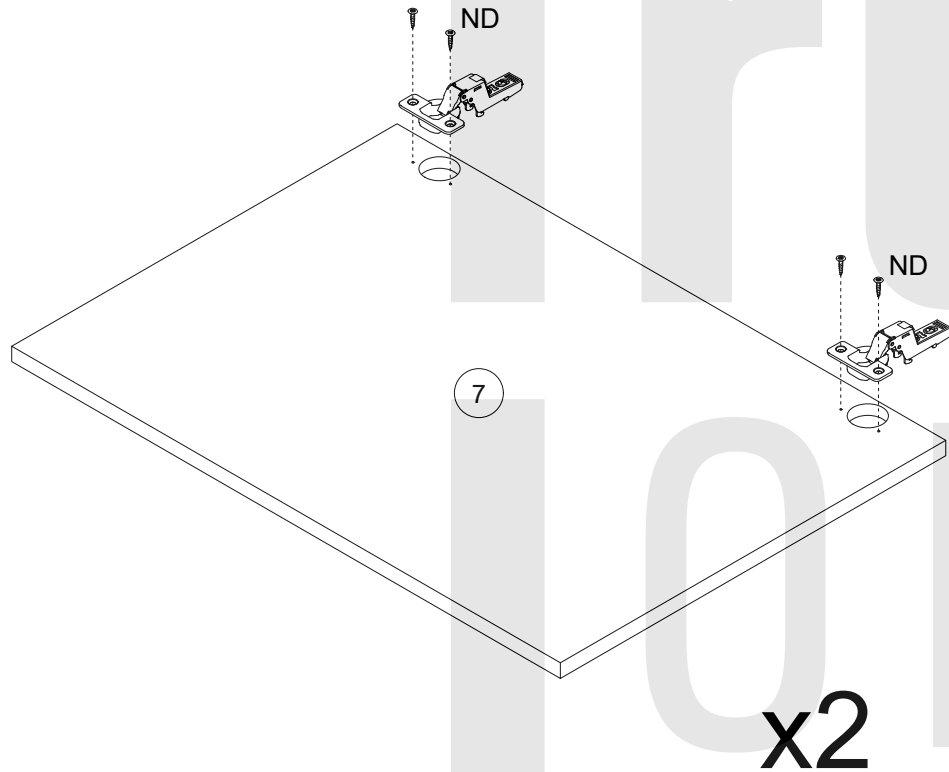
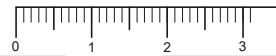
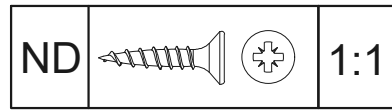

4

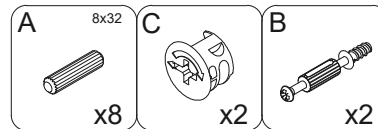
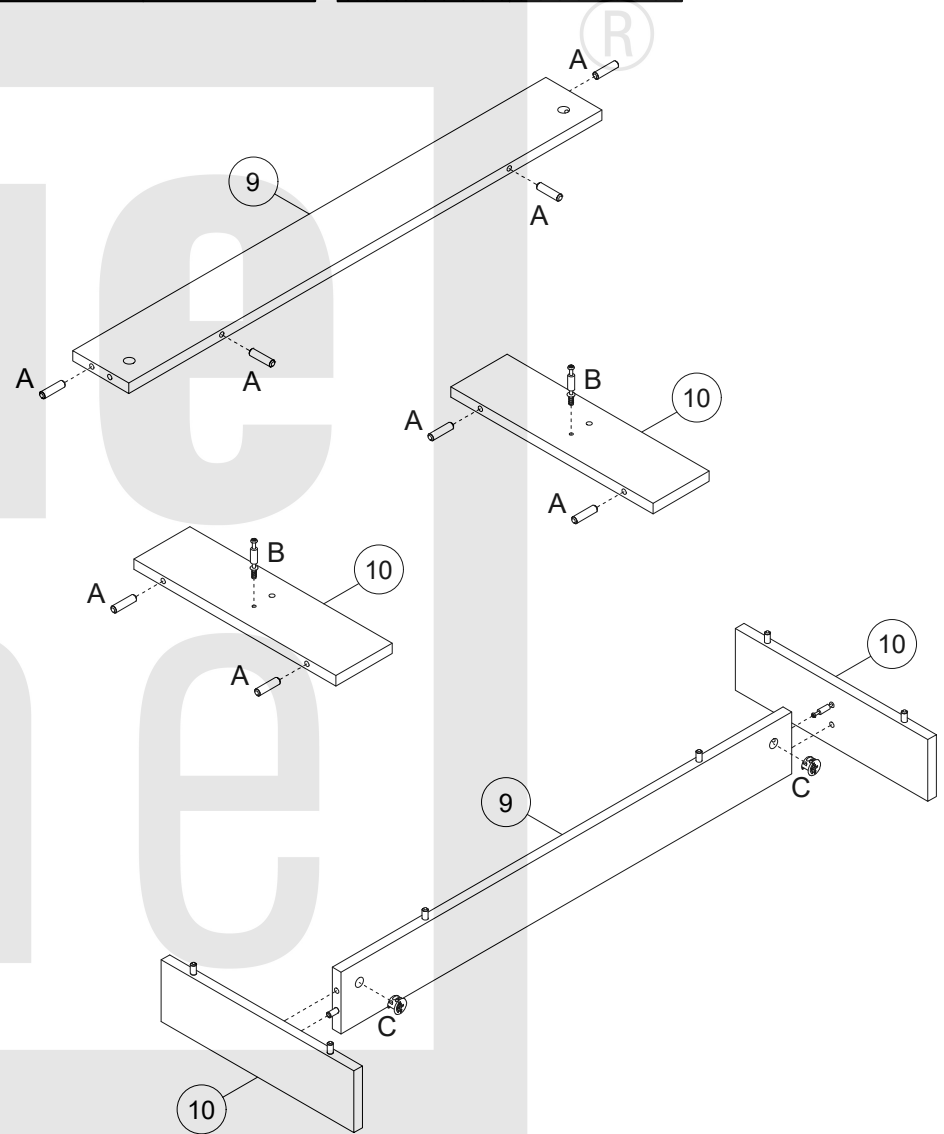
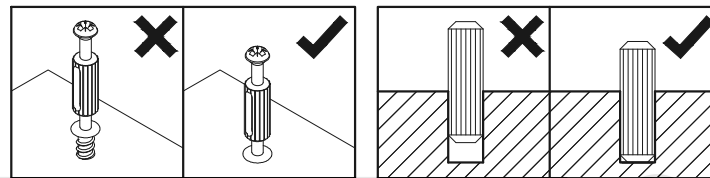

5

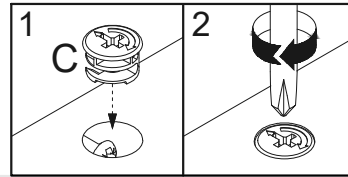
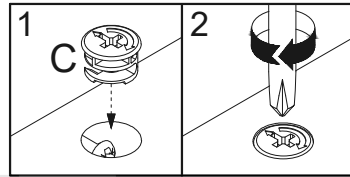

6

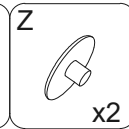
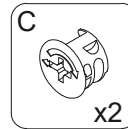
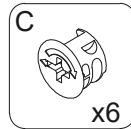
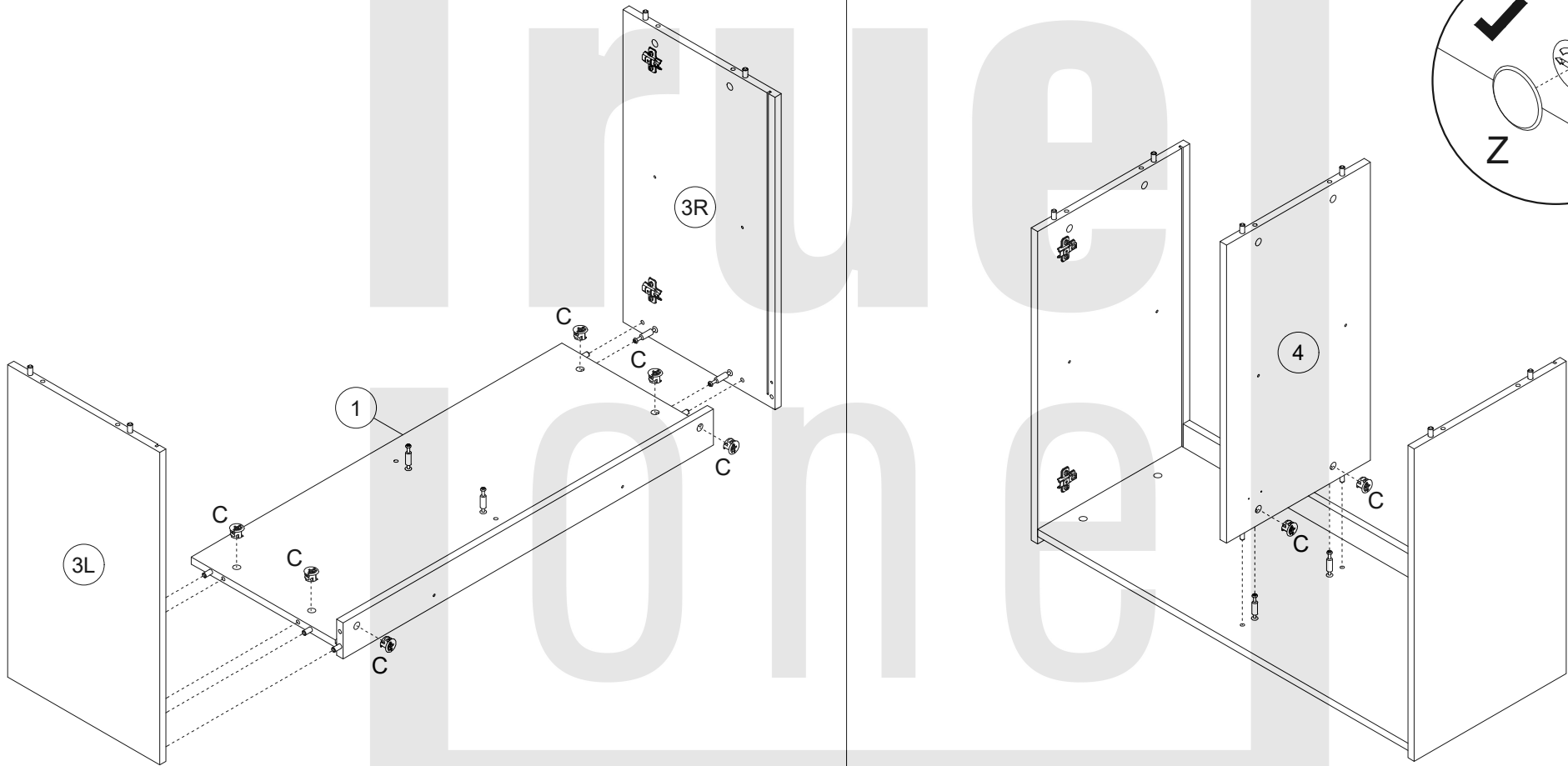

7

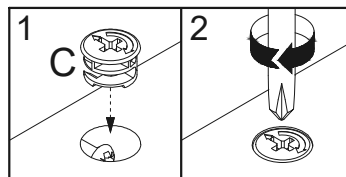
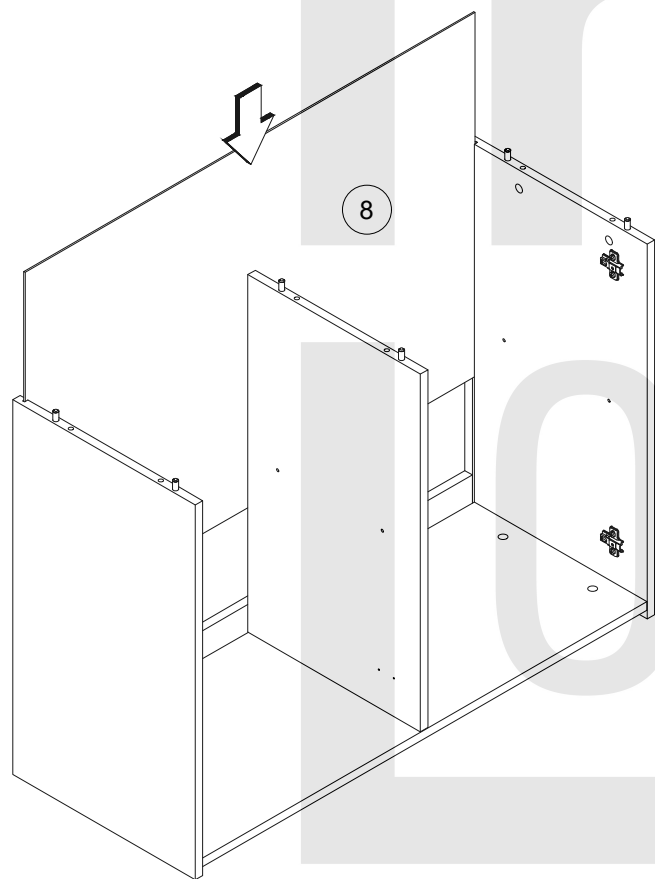

8

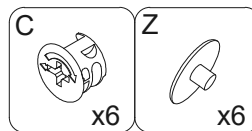
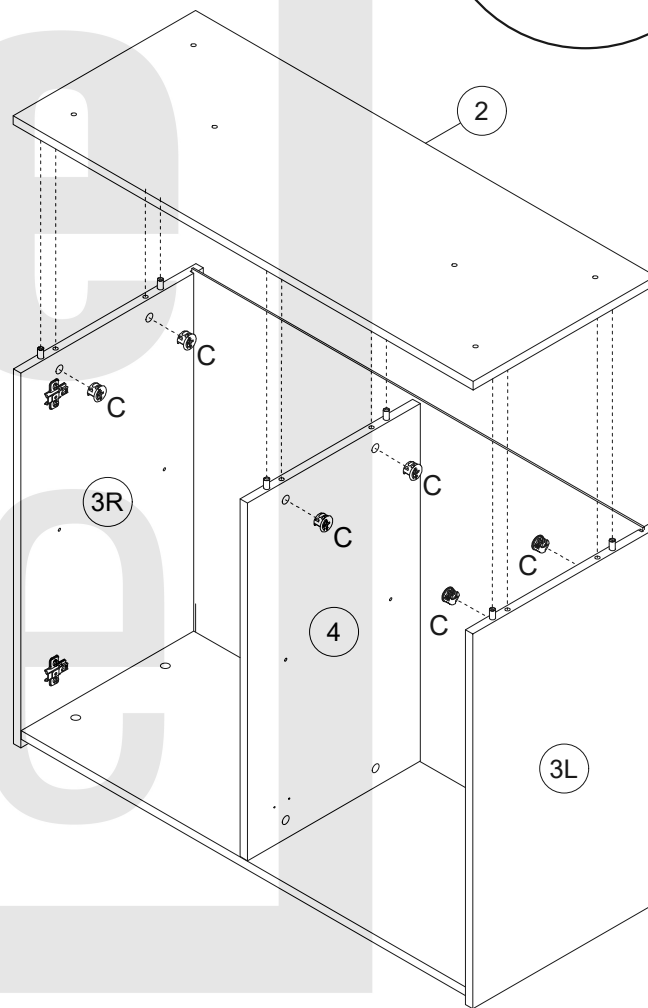
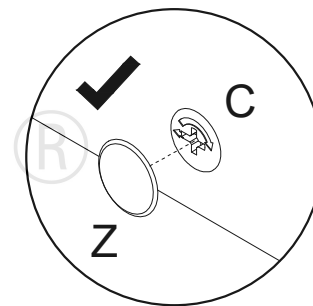

9

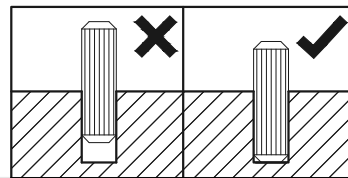
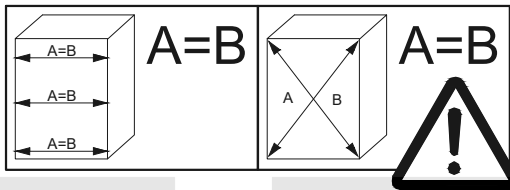
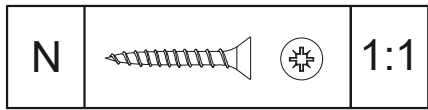

10

